

JVC



CD RECEIVER

KD-SH99

ENGLISH

RECEPTOR CON CD

KD-SH99

ESPAÑOL

RECEPTEUR CD

KD-SH99

FRANÇAIS

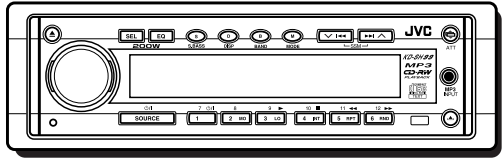
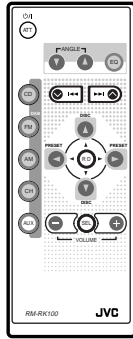
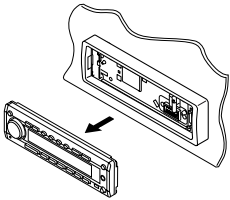

For installation and connections, refer to the separate manual.
Para la instalación y las conexiones, refiérase al manual separado.
Pour l'installation et les raccordements, se référer au manuel séparé.

INSTRUCTIONS

MANUAL DE INSTRUCCIONES
MANUEL D'INSTRUCTIONS

For customer Use:

Enter below the Model No. and Serial No. which are located on the top or bottom of the cabinet. Retain this information for future reference.

Model No. _____

Serial No. _____

INFORMATION (For U.S.A.)

This equipment has been tested and found to comply with the limits for a Class B digital device, pursuant to Part 15 of the FCC Rules. These limits are designed to provide reasonable protection against harmful interference in a residential installation. This equipment generates, uses, and can radiate radio frequency energy and, if not installed and used in accordance with the instructions, may cause harmful interference to radio communications. However, there is no guarantee that interference will not occur in a particular installation. If this equipment does cause harmful interference to radio or television reception, which can be determined by turning the equipment off and on, the user is encouraged to try to correct the interference by one or more of the following measures:

- Reorient or relocate the receiving antenna.
- Increase the separation between the equipment and receiver.
- Connect the equipment into an outlet on a circuit different from that to which the receiver is connected.
- Consult the dealer or an experienced radio/TV technician for help.

IMPORTANT FOR LASER PRODUCTS**Precautions:**

1. CLASS 1 LASER PRODUCT
2. **DANGER:** Invisible laser radiation when open and interlock failed or defeated. Avoid direct exposure to beam.
3. **CAUTION:** Do not open the top cover. There are no user-serviceable parts inside. Leave all servicing to qualified service personnel.
4. **CAUTION:** This CD player uses invisible laser radiation, however, is equipped with safety switches to prevent radiation emission when unloading CDs. It is dangerous to defeat the safety switches.
5. **CAUTION:** Use of controls, adjustments or performance of procedures other than those specified herein may result in hazardous radiation exposure.

How to reset your unit

Press the reset button on the front panel using a ball-point pen or similar tool.

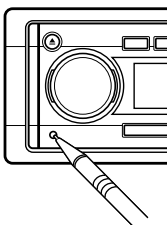
**Note:**

Your preset adjustments – such as preset channels or sound adjustments – will be erased.

CAUTION:

NEVER insert your finger in between the control panel and the unit, as it may get caught or hurt. (See page 29.)

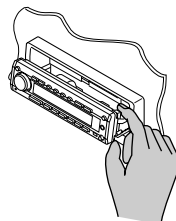
**BEFORE USE*****For safety...**

- Do not raise the volume level too much, as this will block outside sounds, making driving dangerous.
- Stop the car before performing any complicated operations.

***Temperature inside the car...**

If you have parked the car for a long time in hot or cold weather, wait until the temperature in the car becomes normal before operating the unit.

Thank you for purchasing a JVC product. Please read all instructions carefully before operation, to ensure your complete understanding and to obtain the best possible performance from the unit.

CONTENTS

How to reset your unit	2	SOUND ADJUSTMENTS	21
LOCATION OF THE BUTTONS	4	Adjusting the sound	21
Control panel	4	Reinforcing the bass sound	21
Remote controller	5	Selecting preset sound modes	22
Preparing the remote controller	6	Storing your own sound adjustments	23
BASIC OPERATIONS	7	OTHER MAIN FUNCTIONS	24
RADIO BASIC OPERATIONS	8	Setting the clock	24
Listening to the radio	8	Changing the general settings (PSM)	24
Storing stations in memory	9	Assigning names to the sources	28
Tuning into a preset station	10	Changing the control panel angle	29
CD OPERATIONS	11	Detaching the control panel	30
Playing a CD	11	EXTERNAL COMPONENT OPERATIONS ..	31
Locating a track or particular portion on a CD	12	Playing external components	31
Selecting CD playback modes	12	CD CHANGER OPERATIONS	33
Playing a CD Text	13	Playing CDs	33
Prohibiting disc ejection	13	Selecting CD playback modes	34
MP3 INTRODUCTION	14	ADDITIONAL INFORMATION	35
What is MP3?	14	TROUBLESHOOTING	36
How are MP3 files recorded and played back?	14	MAINTENANCE	38
MP3 OPERATIONS	16	Handling discs	38
Playing an MP3 disc	16	SPECIFICATIONS	39
Locating a file or particular portion on an MP3 disc	17		
Selecting MP3 playback modes	20		

About the demonstration mode (DEMO MODE)...

When shipped from the factory, "DEMO MODE" is set to "DEMO ON" in this unit.

The following demonstration, introducing the main features equipped with this unit, will appear on the display automatically if no sound comes in for 3 minutes. (See page 27.)

- **MP3** : (Enables you to play MP3 discs.)
- **24bit DAC** : (24 bit digital-analog converter: Gives you a high quality sound after D/A conversion.)
- **HS TUNER** : (High-sensitivity Tuner: Enables a fine reception of stations.)
- **EQUALIZER** : (Enables you to fine-adjust the sound to match your preference.)
- **SUB WOOFER**: (Enables you to connect a subwoofer and to adjust its output level.)

CAUTION on Volume Setting

CDs produce very little noise compared with other sources. If the volume level is adjusted for the tuner, for example, the speakers may be damaged by the sudden increase in the output level. Therefore, lower the volume before playing a disc and adjust it as required during playback.



LOCATION OF THE BUTTONS

Control panel

16

15

14

13

12

11

10

9

8

7

6

5

4

3

2

1

▲ (eject) button

Control dial

SEL (select) button

EQ (equalization) button

S.BASS (S) (super bass) button

DISP (D) (display) button

BAND (B) button

MODE (M) button

▼ ◀▶▶▶ ▲ buttons

- Also function as SSM buttons when pressed together.

ATT (angle/attenuator) button

MP3 INPUT jack

▲ (control panel release) button

Remote sensor

Number buttons

- MO (monaural) button
- LO (local) button
- INT (intro scan) button
- RPT (repeat) button
- RND (random) button
- DVD/Video component operation buttons

SOURCE (standby/on) button

Reset button

How to use MODE (M):

If you press MODE (M), this button functions as the Mode button and the unit goes into functions mode whereby the number buttons and ◀▶▶▶ buttons work as different function buttons.

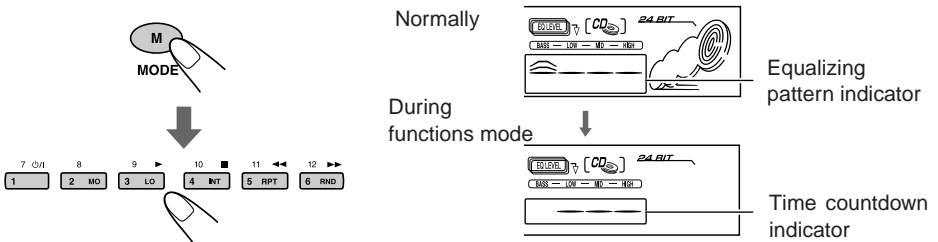

To use these buttons as number buttons and ◀▶▶▶ buttons again after pressing MODE (M), wait for 5 seconds without pressing any number button until the functions mode is cleared.

- Pressing MODE (M) again also clears the functions mode.



Remote controller

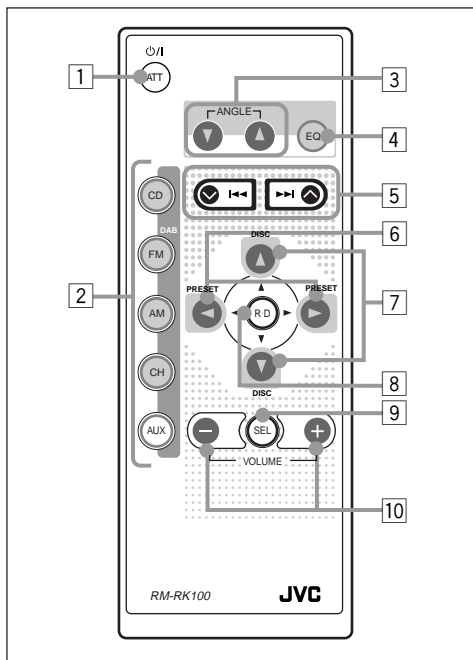

- 1 • Turns on the unit if pressed when the unit is turned off.
 - Turns off the unit if pressed and held until "SEE YOU" appears on the display.
 - Drops the volume level if pressed briefly, and "ATT" flashes on the display. Press again to resume the volume.
- 2 • CD : Selects CD player.
 - FM : Selects FM tuner. Each time you press the button, FM band (FM1, FM2 and FM3) changes.
 - Does not function as the DAB button.
 - AM : Selects AM tuner.
 - CH : Selects CD changer.*
 - AUX : Selects the external components. Each time you press the button, "AUX INPUT" and "LINE INPUT" are alternately selected.

- 3 Changes the angle of the control panel to four positions.

- 4 Selects the sound modes. Each time you press the button, sound modes change.
- 5 • Searches for stations while listening to the radio.
 - Fast-forwards or reverses the track/file if pressed and held while listening to any disc.
 - Skips to the beginning of the next track/file or goes back to the beginning of the current (or previous) track/file if pressed briefly while listening to any disc. (See pages 12 and 17.)
- 6 • Changes the preset channel number while listening to the radio. Each time you press the button, the preset channel number changes, and the selected station is tuned into.
 - Skips to the first file of the next directory or the first file of the previous directory if pressed and held while listening to an MP3 disc. (See page 18.)
 - Skips to the first file of the next directory or the first file of the previous directory of the same hierarchy level if pressed briefly while listening to an MP3 disc. (See page 19.)
- 7 • Changes the disc number while listening to the CD changer. Each time you press the button, the disc number changes, and the selected disc starts playing.
 - Skips to the first file of a directory of an upper hierarchy level or a lower hierarchy level if pressed briefly while listening to an MP3 disc. (See page 19.)
- 8 Skips to the root directory while listening to an MP3 disc. (See page 19.)
- 9** Selects the sound adjustment items. Each time you press the button, the items change.
- 10** • Changes the volume.
 - Adjusts the sound mode (after SEL is pressed).

* Without connecting the CD changer, you cannot select it as the source to play.

** These buttons do not function for the preferred setting mode adjustment.



Preparing the remote controller

Before using the remote controller:

- Aim the remote controller directly at the remote sensor on the main unit. Make sure there is no obstacle in between.

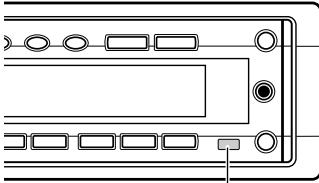

Remote sensor

- Do not expose the remote sensor to strong light (direct sunlight or artificial lighting).

Installing the battery

When the controllable range or effectiveness of the remote controller decreases, replace the battery.

1. Remove the battery holder.

- 1) Push out the battery holder in the direction indicated by the arrow using a ball-point pen or a similar tool.
- 2) Remove the battery holder.

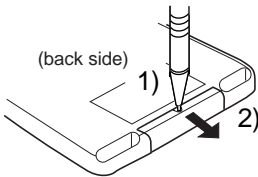

2. Place the battery.

Slide the battery into the holder with the + side facing upwards so that the battery is fixed in the holder.

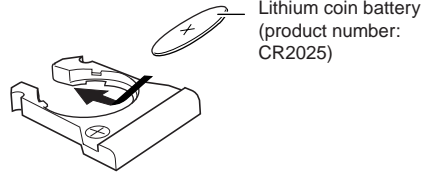

3. Return the battery holder.

Insert again the battery holder pushing it until you hear a clicking sound.

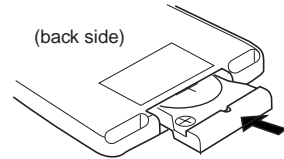

WARNING:

- Store the battery in a place where children cannot reach.
If a child accidentally swallows the battery, consult a doctor immediately.
- Do not recharge, short, disassemble, heat or dispose the battery in a fire.
Doing any of these things may cause the battery to give off heat, crack or start a fire.
- Do not leave the battery with other metallic materials.
Doing this may cause the battery to give off heat, crack or start a fire.
- When throwing away or saving the battery, wrap it in tape and insulate; otherwise, the battery may start to give off heat, crack or start a fire.
- Do not poke the battery with tweezers or similar tools.
Doing this may cause the battery to give off heat, crack or start a fire.

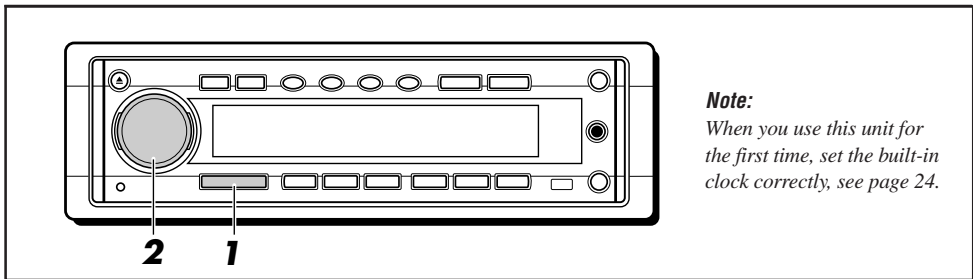

Note:
When you use this unit for the first time, set the built-in clock correctly, see page 24.

1 Turn on the power and select the source.

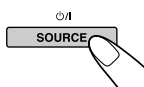

When you press the button for the first time, the power comes on. Then each time you press the button, the source changes as follows:

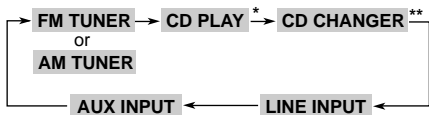

* If a disc is not in the loading slot, you cannot select CD as the source to play.

** Without connecting the CD changer, you cannot select it as the source to play.

To operate the tuner (FM or AM), see pages 8 – 10.

To play a CD, see pages 11 – 13.

To play an MP3 disc, see pages 16 – 20.

To operate external components (AUX INPUT and LINE INPUT), see pages 31 – 32.

To operate the CD changer, see pages 33 – 34.

2 Adjust the volume.

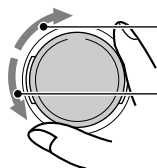

To increase the volume.

To decrease the volume.

Volume level appears.

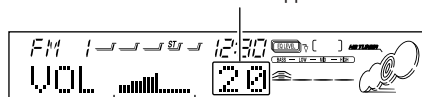

Volume level indicator

Note:

After adjusting the volume, you can push in the control dial to avoid unintended operations. To use it again, push the control dial again to make it come out.

3 Adjust the sound as you want. (See page 21.)

To drop the volume in a moment

Press and hold /ATT while listening to any source. “ATT” starts flashing on the display, and the volume level will drop in a moment.

To resume the previous volume level, press and hold the button again.

- If you turn the control dial clockwise, you can also restore the sound.

To turn off the power

Press and hold SOURCE until “SEE YOU” appears on the display.

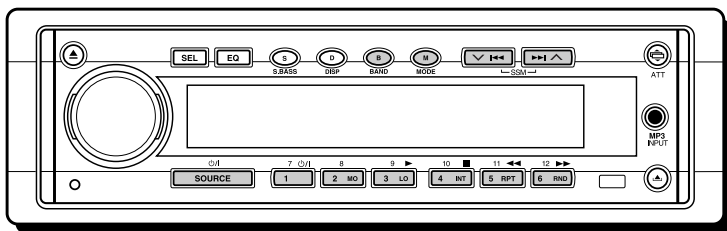

Listening to the radio

You can use either automatic searching or manual searching to tune into a particular station.

Searching a station automatically: Auto search

1 Select the band (FM1 – 3, AM).

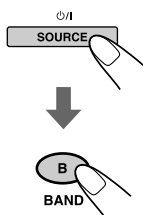

- 1 Press SOURCE ϕ/I repeatedly to select the tuner as the source.
- 2 If necessary, press BAND (B) repeatedly to select FM or AM. Each time you press the button, the band changes as follows:

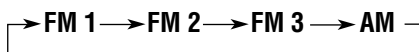

Selected band appears.

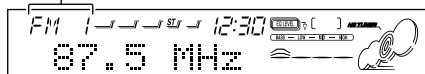

Note:

This receiver has three FM bands (FM1, FM2, FM3). You can use any one of them to listen to an FM broadcast.

2 Start searching a station.

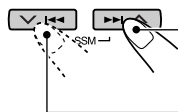

Press $\blacktriangleright \blacktriangle$ to search stations of higher frequencies.

Press $\blacktriangleleft \blacktriangleright$ to search stations of lower frequencies.

When a station is received, searching stops.

To stop searching before a station is received, press the same button you have pressed for searching.

To tune into FM stations only with strong signals

- 1 Press MODE (M) to enter the functions mode while listening to an FM broadcast.
- 2 Press LO (local) while still in the functions mode, so that the LOCAL indicator lights up on the display. This function works only while searching FM stations, including SSM preset. Each time you press the button, the LOCAL indicator lights up and goes off alternately.

Searching a station manually: Manual search

1 Select the band (FM1 – 3, AM).

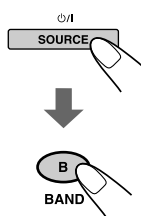

- 1 Press SOURCE ϕ/I repeatedly to select the tuner as the source.
- 2 If necessary, press BAND (B) repeatedly to select FM or AM. Each time you press the button, the band changes as follows:

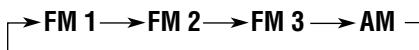

Note:

This receiver has three FM bands (FM1, FM2, FM3). You can use any one of them to listen to an FM broadcast.

2 Press and hold **▶▶** **▲** or **▼** **◀◀** until “M” (manual) starts flashing on the display.

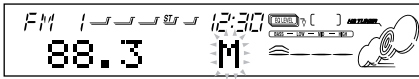
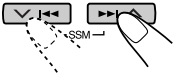

3 Tune into a station you want while “M” is flashing.

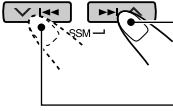

Press **▶▶** **▲** to tune into stations of higher frequencies.

Press **▼** **◀◀** to tune into stations of lower frequencies.

- If you release your finger from the button, the manual mode will automatically turn off after 5 seconds.
- If you hold down the button, the frequency keeps changing until you release the button.

Storing stations in memory

You can use one of the following two methods to store broadcasting stations in memory.

- Automatic preset of FM stations: SSM (Strong-station Sequential Memory)
- Manual preset of both FM and AM stations

FM station automatic preset: SSM

You can preset 6 local FM stations in each FM band (FM1, FM2 and FM3).

1 Select the FM band (FM1 – 3) you want to store FM stations into.

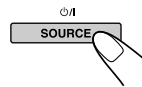

1 Press **SOURCE** **⊕/1** repeatedly to select the tuner as the source.

2 If necessary, press **BAND** (B) repeatedly to select the FM band.

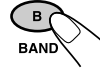

Each time you press the button, the band changes as follows:

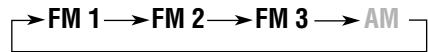

2 Press and hold both buttons for more than 2 seconds.

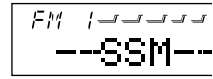
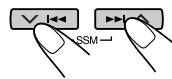

“SSM” appears, then disappears when automatic preset is over.

Local FM stations with the strongest signals are searched and stored automatically in the band number you have selected (FM1, FM2 or FM3). These stations are preset in the number buttons — No.1 (lowest frequency) to No.6 (highest frequency).

When automatic preset is over, the station stored in number button 1 will be automatically tuned into.

When an FM stereo broadcast is hard to receive:



1 Press **MODE** (M) to enter the functions mode while listening to an FM stereo broadcast.

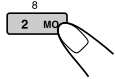

2 Press **MO** (monaural) while still in the functions mode, so that the MO indicator lights up on the display.

- Each time you press the button, the MO and ST (stereo) indicators light up alternately.

Lights up when receiving an FM broadcast in stereo.

The MO indicator lights up.



When the MO indicator is lit on the display, the sound you hear becomes monaural but the reception will be improved (the ST indicator goes off).



Manual preset

You can preset up to 6 stations in each band (FM1, FM2, FM3 and AM) manually.

Ex.: Storing an FM station of 88.3 MHz into the preset number 1 of the FM1 band

1 Select the band (FM1 – 3, AM) you want to store stations into (in this example, FM1).

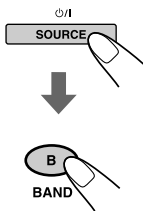

- 1 Press SOURCE $\phi/1$ repeatedly to select the tuner as the source.
- 2 If necessary, press BAND (B) repeatedly to select FM 1. Each time you press the button, the band changes as follows:

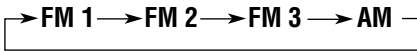

2 Tune into a station of 88.3 MHz.

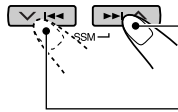

Press $\blacktriangleright \blacktriangleleft \blacktriangleup$ to tune into stations of higher frequencies.

Press $\blacktriangledown \blacktriangleleft \blacktriangleleft$ to tune into stations of lower frequencies.

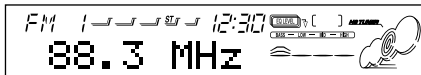

3 Press and hold the number button (in this example, 1) for more than 2 seconds.

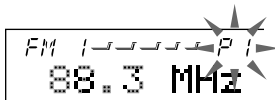

"P1" flashes for a while.

4 Repeat the above procedure to store other stations into other preset numbers.

Notes:

- A previously preset station is erased when a new station is stored in the same preset number.
- Preset stations are erased when the power supply to the memory circuit is interrupted (for example, during battery replacement). If this occurs, preset the stations again.

Tuning into a preset station

You can easily tune into a preset station.

Remember that you must store stations first. If you have not stored them yet, see "Storing stations in memory" on page 9.

1 Select the band (FM1 – 3, AM).

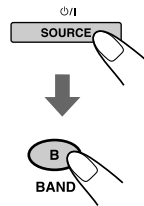

- 1 Press SOURCE $\phi/1$ repeatedly to select the tuner as the source.
- 2 If necessary, press BAND (B) repeatedly to select FM or AM. Each time you press the button, the band changes as follows:

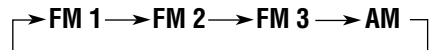

2 Select the number (1 – 6) for the preset station you want.

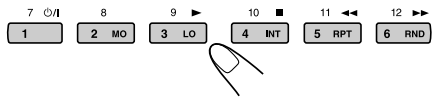

If the sound quality decreases and the stereo effect is lost while listening to an FM station...

In some areas, adjacent stations may interfere with each other. If this interference occurs, this unit can automatically reduce this interference noise (the initial setting when shipped from the factory). However, in this case, the sound quality will be degraded and the stereo effect will be also lost.

If you do not want to degrade the sound quality and to lose the stereo effect, rather than to eliminate the interference noise, see "To change the FM tuner selectivity – IF FILTER" on page 27.

When using this until in an area other than North or South America:

You need to change the AM/FM channel intervals. See "To change the AM/FM channel intervals – AREA" on pages 26 and 27.

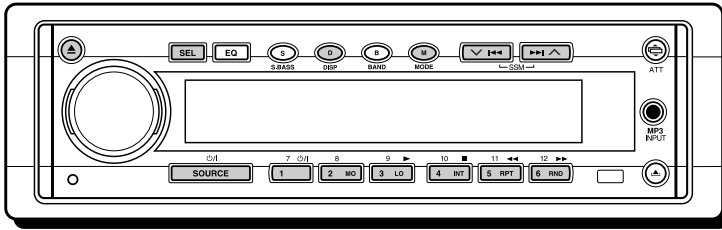

When playing an MP3 disc, refer also to “MP3 OPERATIONS” on pages 16 to 20.

Playing a CD

1 Open the loading slot.



The control panel moves down, and the loading slot appears.

Note:

When an external component is connected to the MP3 INPUT jack, be careful of handling a CD.

2 Insert a disc into the loading slot.

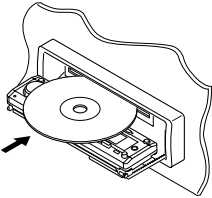

The unit draws the disc, the control panel goes back to its previous position (see page 29), and CD play starts automatically.

- All the tracks on the disc will be played repeatedly until you stop playback—All Track Repeat Play.

Note:

Do not insert any 8 cm disc into the loading slot as it will get stuck inside.

The display changes to show the following:

--- CDPLAY

10 63' 18"

Total track number of the inserted disc

Total playing time of the inserted disc

01 00' 02"

Current track

Elapsed playing time

Notes:

- When a disc is in the loading slot, selecting “CD” as the source by pressing SOURCE starts CD play.
- When a disc is inserted upside down, the disc automatically ejects.
- When you play a CD Text, the disc title and performer appear on the display. Then the current track title appears on the display, followed by the track number and elapsed playing time. See also “Playing a CD Text” (page 13) and “To select the scroll mode – SCROLL” (page 26). If a CD Text includes too much text information, some may not appear on the display.
- If you change the source, CD play also stops (without ejecting the disc).

To stop play and eject the disc

Press ▲.

CD play stops, the control panel moves down, and the disc automatically ejects from the loading slot.

To return the control panel to its previous position, press ▲ again.

- If you keep the loading slot open for one minute (or 30 seconds when you have ejected a disc with the ignition key turned to “OFF”), a beep sounds and the control panel returns to its previous position.

Be careful not to get the disc or your finger caught in between the control panel and the unit.

Note:

If the ejected disc is not removed within 15 seconds, the disc is automatically inserted again into the loading slot to protect it from dust. (CD play will not start this time.)



Locating a track or particular portion on a CD

To fast-forward or reverse the track

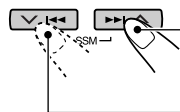

Press and hold **▶▶▶ ▲** while playing a disc, to fast-forward the track.
Press and hold **▼ I◀◀** while playing a disc, to reverse the track.

To go to the next track or the previous tracks

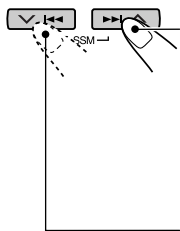

Press **▶▶▶ ▲** briefly while playing a disc, to go ahead to the beginning of the next track. Each time you press the button consecutively, the beginning of the next track is located and played back.

Press **▼ I◀◀** briefly while playing a disc, to go back to the beginning of the current track. Each time you press the button consecutively, the beginning of the previous tracks is located and played back.

To go to a particular track directly

Press the number button corresponding to the track number to start its playback.

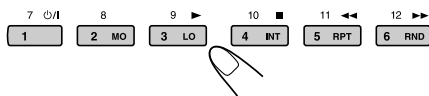

- To select a track number from 1 – 6:
Press 1 (7) – 6 (12) briefly.
- To select a track number from 7 – 12:
Press and hold 1 (7) – 6 (12) for more than 1 second.

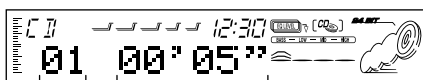

Track number Elapsed playing time

Selecting CD playback modes

To play back tracks at random (Random Play)

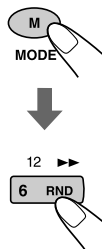

- 1 Press MODE (M) while playing a disc. The unit enters the functions mode.
- 2 Press RND (random) while still in the functions mode, so that the RND indicator lights up on the display. Then, each time you press RND, the random play mode turns on and off alternately.

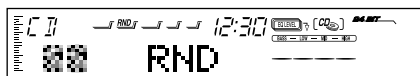

When the random mode is turned on, the RND indicator lights up on the display and a track randomly selected starts playing.

To play back the current track repeatedly (One Track Repeat Play)



- 1 Press MODE (M) while playing a disc. The unit enters the functions mode.
- 2 Press RPT (repeat) while still in the functions mode, so that the RPT indicator lights up on the display. Then, each time you press RPT, the One Track Repeat Play mode turns on and off alternately.
 - When One Track Repeat Play is turned off, All Track Repeat Play is activated.

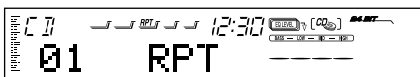



To play back only intros (Intro scan)

You can play back the first 15 seconds of each track sequentially.

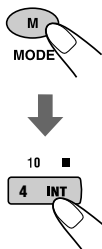

- 1 Press MODE (M) while playing a disc. The unit enters the functions mode.
- 2 Press INT (intro scan) while still in the functions mode, so that the "INT" appears on the display. Then, each time you press INT, the intro scan play mode turns on and off alternately.

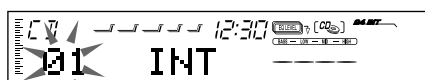

Track number of the currently playing track

Playing a CD Text

In a CD Text, some information about the disc (its disc title, performer and track title) is recorded. You can show these disc information on the display.

1 Select text display mode while playing a CD Text.



Each time you press the button, the display changes as follows:



Notes:

- The display shows up to 10 characters at one time and scrolls if there are more than 10 characters. See also "To select the scroll mode – SCROLL" on page 26.
- When you press DISP (D) while playing a conventional CD, "NO NAME" appears for the disc title/performer and the track title.

Prohibiting disc ejection

You can prohibit disc ejection and can lock a disc in the loading slot.

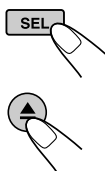

While pressing SEL (select), press and hold ▲ for more than 2 seconds. "NO EJECT" flashes on the display for about 5 seconds, and the disc is locked and cannot be ejected.



Note:

If you press ▲ while disc ejection is prohibited, the control panel moves down, but the disc cannot be ejected.

To return the display panel to its previous position, press ▲.

To cancel the prohibition and unlock the disc, press and hold ▲ for more than 2 seconds again, while pressing SEL.

"EJECT OK" flashes on the display for about 5 seconds, and the disc is unlocked.



What is MP3?

MP3 is an abbreviation of Motion Picture Experts Group (or MPEG) Audio Layer 3. MP3 is simply a file format with a data compression ratio of 1:10 (128 Kbps*). That means, by using MP3 format, one CD-R or CD-RW can contain 10 times as much data volume as a regular CD can.

* Bit rate is the average number of bits that one second of audio data will consume. The unit used is Kbps (1000 bits/second). To get a better audio quality, choose a higher bit rate. The most popular bit rate for encoding is 128 Kbps.

This unit is incorporated with an MP3 decoder. You can play back MP3 files (tracks) recorded on CD-Rs, CD-RWs, and CD-ROMs.

Compatible with ID3v1

Extra information data such as album title, performer name, song title, recording year, music genre and a brief comment can be stored within an MP3 file.

- This unit can show ID3v1 tags (album name, performer name and song title) on the display.
- Some characters cannot be shown correctly.
- This unit is not compatible with ID3v2.

Other Main Features in this unit:

- Maximum number of hierarchy levels: 8
- Maximum number of directories/files: 255 (Total)
- Available characters: A–Z, 0–9, _ (underscore)
- Maximum number of characters for file name (ISO 9660 Level 1): 12 (inclusive of separation mark—“.” and extension code—“mp3”)
- (ISO 9660 Level 2): 31 (inclusive of separation mark—“.” and extension code—“mp3”)
- Maximum number of characters for directory name: 31

Precautions when recording MP3 files on a CD-R or CD-RW

This unit can only read MP3 files that are recorded in the format that is compliant with ISO 9660 Level 1 or Level 2.

How are MP3 files recorded and played back?

MP3 “files (tracks)” can be recorded in “directories (folders)”—in PC terminology. During recording, the files and directories can be arranged in a way similar to arranging files and directories/folders of computer data.

“Root” is similar to the root of a tree. Every file and directory can be linked to and be accessed from the root.

In compliance with ISO 9660, the maximum allowable depth of nested directories—so-called “hierarchy”—is eight (inclusive of the root directory).

Playback order, file search order, and directory search order of the MP3 files recorded on a disc are determined by the writing (or encoding) application; therefore, playback order may be different from the one you have intended while recording the directories and the files.

The illustration on the next page shows an example of how MP3 files are recorded on a CD-R or CD-RW, how they are played back, and how they are searched on this unit.

Notes:

- The unit can read a CD-ROM containing MP3 files. However, if non-MP3 files are recorded together with MP3 files, this unit will take a longer time to scan the disc. It may also cause the unit to malfunction.
- The unit cannot read or play an MP3 file without the extension code—mp3.
- The unit is not compatible with Playlist**.

** A playlist is a simple text file, used on a PC, which enables users to make their own playback order without physically rearranging the files.



MP3 directory/file configuration

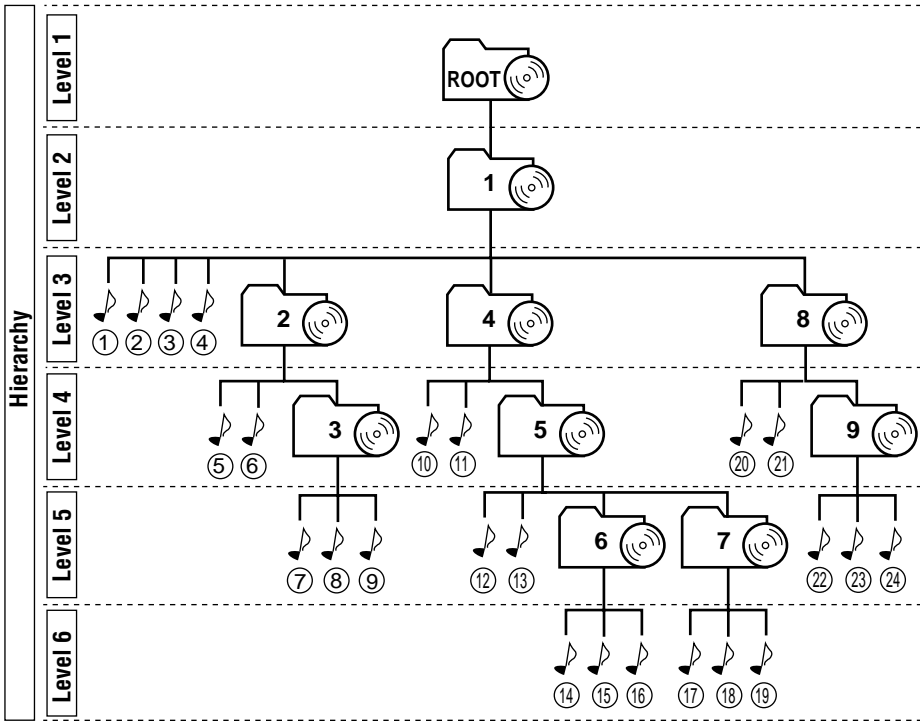

	: Root
	: Directories
	: MP3 files

Notes:

- In compliance with ISO 9660, the maximum number of hierarchy levels is eight, including the root directory.
- When a multi-session disc is loaded, you can only play back the contents of the last session.

MP3 playback/search order (page 17)

- The numbers in circles next to the MP3 files () indicate the playback order and search order of the MP3 files. Normally this unit plays back MP3 files in the recorded order.
- The numbers inside the directories indicate the playback order and search order of the directories on an MP3 disc. Normally this unit plays back MP3 files in the directories in the recorded order.

Movement between the directories (page 19)

You can move to another directory on the same hierarchy level (e.g. from Directory 3, you can go to Directory 5 or 9) or on a different hierarchy level (e.g. from Directory 5, you can go to Directory 4 or 6).

MP3 OPERATIONS

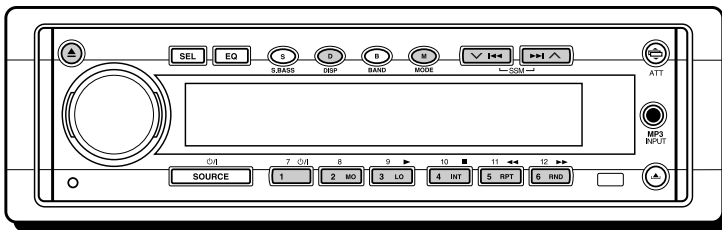

Refer also to “CD OPERATIONS” on pages 11 to 13.

Playing an MP3 disc

1 Open the loading slot.



The control panel moves down, and the loading slot appears.

2 Insert an MP3 disc into the loading slot.

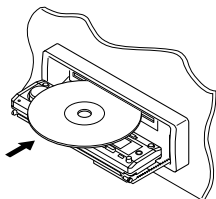

The unit draws the disc, the control panel goes back to its previous position (see page 29), and playback starts automatically.

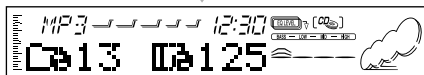

Ex.: When the disc contains 13 directories and 125 MP3 files.

Playback starts automatically from the first file of the first directory once file check is completed.

Then, the display changes to show the following:

- When “TAG ON” is selected (initial setting: see page 27)

Album name/performer name (directory name)* → Track title (file name)* → Elapsed playing time

* If an MP3 file does not have ID3 tags, directory name and file name appear.

- When “TAG OFF” is selected
Directory name and file name appear.

Notes:

- All the files on the disc will be played repeatedly until you stop playback—All File Repeat Play.
- MP3 discs require a longer readout time**. (It differs due to the complexity of the directory/file configuration.)

** Readout time is the time taken by the unit to scan or check the disc for files and file information.



To change the display information



While playing back an MP3 file, you can change the file information shown on the display.

Each time you press DISP (D), the display changes to show the following:

- When “TAG ON” is selected (initial setting: see page 27)

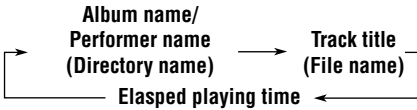

* If an MP3 file does not have ID3 tags, directory name and file name appear.

- When “TAG OFF” is selected

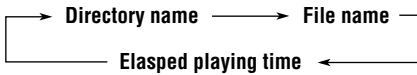

Note:

- The display shows up to 10 characters at one time and scrolls if there are more than 10 characters. See also “To select the scroll mode – SCROLL” on page 26.

To stop play and eject the disc

Press **▲**.

Playback stops, the control panel moves down and the disc automatically ejects from the loading slot.

Locating a file or particular portion on an MP3 disc

To fast-forward or reverse the file

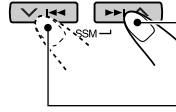

Press and hold **▶▶ ▲** while playing an MP3 disc, to fast-forward the file.

Press and hold **▼ ◀◀** while playing an MP3 disc, to reverse the file.

To skip to the next file or the previous files

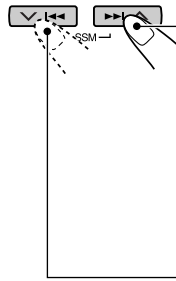

Press **▶▶ ▲** briefly while playing, to skip ahead to the beginning of the next file. Each time you press the button consecutively, the beginning of the next file is located and played back. (See “MP3 playback/search order” on page 15.)

Press **▼ ◀◀** briefly, while playing, to skip back to the beginning of the current file. Each time you press the button consecutively, the beginning of the previous files is located and played back. (See “MP3 playback/search order” on page 15.)



To go to a particular directory directly

IMPORTANT:

To directly select the directories using the number button(s), it is required that directories are assigned 2 digit numbers at the beginning of their directory names. (This can only be done during the recording of CD-Rs or CD-RWs.)

Ex.: If directory name is "01 ABC"

→ press 1 to go to directory 01 ABC

If directory name is "1 ABC"

→ pressing 1 does not work

If directory name is "12 ABC"

→ press and hold 6 (12) to go to directory 12 ABC

Press the number button corresponding to the directory number to start playing the first file in the selected directory.

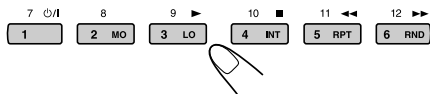

- To select a directory number from 01 – 06:
Press 1 (7) – 6 (12) briefly.
- To select a directory number from 07 – 12:
Press and hold 1 (7) – 6 (12) for more than 1 second.

Notes:

- If "MP3" flashes on the display after you have selected a directory, it means that the directory does not contain any MP3 files.
- You cannot directly select a directory with a number greater than 12.

To select a particular file in a directory, press ►►| ▲ or ▼ |◄◄ after selecting the directory.

To skip to the next directory—either on the same hierarchy level or on a different hierarchy level

On the control panel:

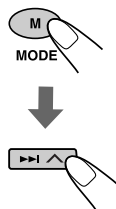

- 1 Press MODE (M) while playing an MP3 disc. The unit enters the functions mode.
- 2 Press ►►| ▲ briefly while still in the functions mode. Each time you repeat steps 1 and 2, the next directory is located (and the first file in the directory starts playing, if recorded).
(See "MP3 playback/search order" on page 15.)

On the remote controller:



Each time you press and hold the button consecutively, the next directory is located (and the first file in the directory starts playing, if recorded).
(See "MP3 playback/search order" on page 15.)

To skip to the previous directory—either on the same hierarchy level or on a different hierarchy level

On the control panel:

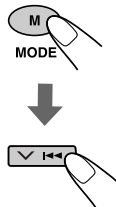

- 1 Press MODE (M) while playing an MP3 disc. The unit enters the functions mode.
- 2 Press ▼ |◄◄ briefly while still in the functions mode. Each time you repeat steps 1 and 2, the previous directory is located (and the first file in the directory starts playing, if recorded).
(See "MP3 playback/search order" on page 15.)

On the remote controller:



Each time you press and hold the button consecutively, the previous directory is located (and the first file in the directory starts playing, if recorded).
(See "MP3 playback/search order" on page 15.)

To skip to the next directory on the same hierarchy level

On the remote controller:



Each time you press the button consecutively, the next directory on the same hierarchy level is located (and the first file in the directory starts playing, if recorded).

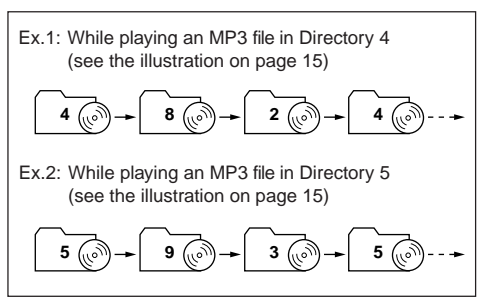

To skip to the previous directory on the same hierarchy level

On the remote controller:

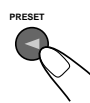

Each time you press the button consecutively, the previous directory on the same hierarchy level is located (and the first file in the directory starts playing, if recorded).

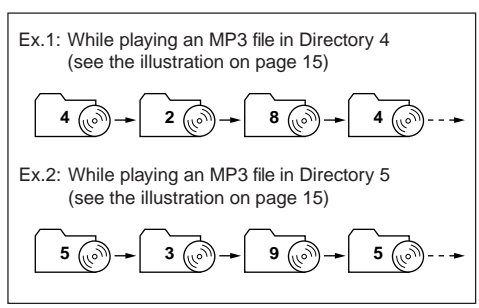

Note:
If there is no MP3 file in a directory that you have skipped to, its directory name appears on the display with "MP3" flashing. If this happens, the unit pauses automatically.

To skip to the directories on the lower hierarchy levels

On the remote controller:



Each time you press the button consecutively, a directory on the lower hierarchy level is located (and the first file in the directory starts playing, if recorded).

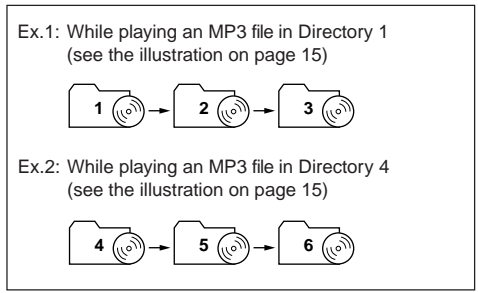

To skip to the directories on the upper hierarchy levels

On the remote controller:

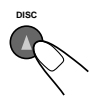

Each time you press the button consecutively, a directory on the upper hierarchy level is located (and the first file in the directory starts playing, if recorded).

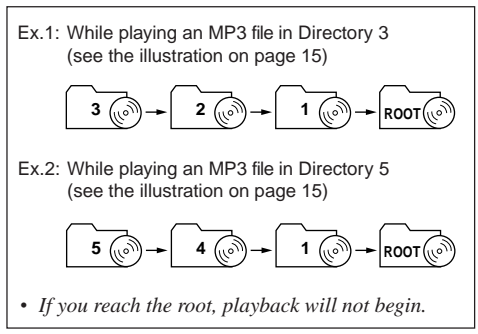

To go back to the root directly, press R•D on the remote controller. You can go back to the root from any directory.

- If files are recorded on the first hierarchy level without putting them into a directory, this unit starts playing the files.



Selecting MP3 playback modes

To play back files at random (Random Play)

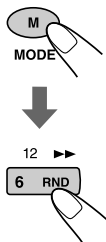

- 1 Press MODE (M) while playing an MP3 disc. The unit enters the functions mode.
- 2 Press RND (random) while still in the functions mode, so that the RND indicator lights up on the display. Then, each time you press RND, the random play mode turns on and off alternately.

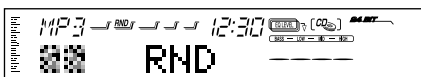

When the random mode is turned on, the RND indicator lights up on the display and a file randomly selected from all the files on the disc starts playing.

To play back only intros (Intro scan)

You can play back the first 15 seconds of each file sequentially.

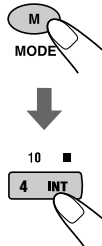

- 1 Press MODE (M) while playing an MP3 disc. The unit enters the functions mode.
- 2 Press INT (intro scan) while still in the functions mode, so that "INT" appears on the display. Then, each time you press INT, the intro scan play mode turns on and off alternately.

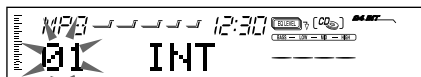

File number of the currently playing file

To play back files repeatedly (Repeat Play)

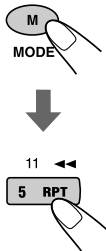

- 1 Press MODE (M) while playing an MP3 disc. The unit enters the functions mode.
- 2 Press RPT (repeat) while still in the functions mode, so that the RPT indicator lights up on the display. Then, each time you press RPT, the repeat play mode changes as follows:



Ex.: When "RPT 1" is selected.

Mode	RPT Indicator	Plays repeatedly
RPT 1	Lights	The current file (or specified file).
RPT 2	Flashes	All files of the current directory (or specified directory).



Adjusting the sound

You can adjust the sound characteristics to your preference.

1 Select the item you want to adjust.



Each time you press the button, the adjustable items change as follows:

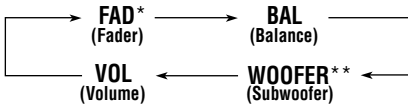

Indication	To do:	Range
FAD*	Adjust the front and rear speaker balance.	R06 (Rear only) F06 (Front only)
BAL	Adjust the left and right speaker balance.	L06 (Left only) R06 (Right only)
WOOFER**	Adjust the subwoofer output level.	00 (min.) 12 (max.)
VOL	Adjust the volume.	00 (min.) 50 (max.)

* If you are using a two-speaker system, set the fader level to "00."

** This takes effect only when a subwoofer is connected.

2 Adjust the level.

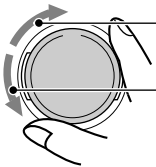

To increase the level.

To decrease the level.

Note:

Normally, the control dial works as the volume control. So you do not have to select "VOL" to adjust the volume level.

Reinforcing the bass sound

The richness and fullness of the bass sound is clearly maintained regardless of how low you set the volume – Super Bass.

- You can also adjust the level of Super Bass.

1 Press S.BASS.



"S.BASS" appears on the display.

2 Adjust Super Bass level from "S. BASS 00" (min.) to "S. BASS 08" (max.).

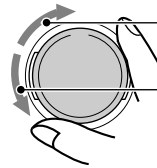

To increase the level.

To decrease the level.

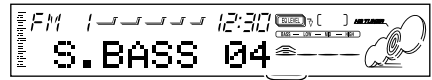

Bass level indicator changes according to the adjusted level.



Selecting preset sound modes

You can select a preset sound mode suitable to the music genre.

1 Press EQ.

EQ



The last selected sound mode is recalled, and it is applied to the current source.

The EQ indicator lights up.

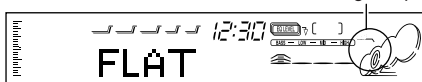

Ex.: When you have selected "FLAT" previously

2 Select the sound mode you want.

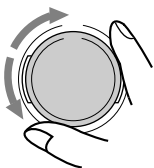

As you turn the control dial, the sound modes change as follows:

FLAT ⇄ Hard Rock ⇄ R & B* ⇄ POP ⇄
JAZZ ⇄ DanceMusic ⇄ Country ⇄ Reggae ⇄
Classic ⇄ USER 1 ⇄ USER 2 ⇄ USER 3 ⇄
(back to the beginning)

* Rhythm and Blues

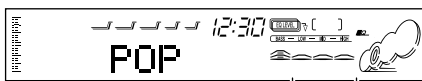

EQ level changes as you select the sound mode.

Ex.: When you select "POP"

To cancel the sound mode, select "FLAT" in step 2.

Notes:

- You can adjust each sound mode to your preference, and store it in memory.
If you want to adjust and store your original sound mode, see "Storing your own sound adjustments" on page 23.
- To adjust the bass reinforcement level temporarily, see page 21.

To store a sound mode separately for each playback source (EQ Link)

Once you select a sound mode, it is stored in memory. It will be recalled every time you select the same source.

A sound mode can be stored for each of the following sources — FM1, FM2, FM3, AM, CD and external components.

- See also "Changing the general settings (PSM)" on page 24.

- Press and hold SEL (select) for more than 2 seconds so that one of the PSM items appears on the display.
- Press ►►| ▲ or ▼ |◄◄ to select "EQ LINK" (Equalization Link).
- Turn the control dial clockwise to select "LINK ON."
- Press SEL (select) to finish the setting.

To cancel EQ Link, repeat the same procedure and select "LINK OFF" by turning the control dial counterclockwise in step 3.

- When "EQ LINK" is set to "LINK ON"**
The selected sound mode can be stored in memory for the current source.
Each time you change to the same source, the same sound mode is also recalled, and shown after the source name.
- When "EQ LINK" is set to "LINK OFF"**
The selected sound mode effect applies to all the sources followed.

Storing your own sound adjustments

You can adjust the sound modes to your preference and store your own adjustments in memory (USER 1, USER 2 and USER 3).

- There is a time limit in doing the following procedure. If the setting is canceled before you finish, start from step 1 again.

1 Press EQ.

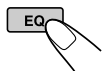

The last selected sound mode is recalled, and is applied to the current source.

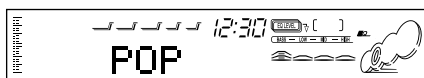

Ex.: When you have selected "POP" previously

2 Press SEL (select) to select sound elements to adjust.



Each time you press the button, the sound elements change as follows:

LOW FREQ.* → LOW WIDTH → LOW LEVEL →
 MID FREQ.* → MID WIDTH → MID LEVEL →
 HIGH FREQ.* → HIGH LEVEL →
 (back to the beginning)

FREQ. (LOW, MID, HIGH):

Select the center frequency to adjust.

WIDTH (LOW, MID):

Select the band width level (Q).

LEVEL (LOW, MID, HIGH):

Adjust the enhancement level.

* By pressing ►►► ▲ or ▼ ◄◄◄, you can directly move as follows:



3 Adjust the selected sound element.

- Refer to the table below for adjusting the selected sound element.

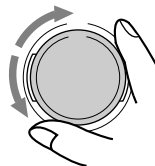

4 Repeat steps 2 and 3 to adjust the other sound elements.

5 Select one of the user sound modes (USER 1, USER 2, USER 3).



Ex.: When you select "USER 2"

6 Press EQ to store the adjustments.



To reset to the factory settings

Repeat the same procedure and reassign the preset values listed in the table on page 35.

Indication	Preset values		
	LOW	MID	HIGH
FREQ.	50 Hz	700 Hz	8 kHz
	80 Hz	1 kHz	12 kHz
	120 Hz	2 kHz	
WIDTH	1 (min.)	1 (min.)	_____
	4 (max.)	2 (max.)	
LEVEL	-06 (min.)	-06 (min.)	-06 (min.)
	+06 (max.)	+06 (max.)	+06 (max.)

Setting the clock

- 1 Press and hold SEL (select) for more than 2 seconds so that one of the PSM items appears on the display. (See page 25.)



- 2 Set the hour.

- 1 Select "CLOCK HOUR" if not shown on the display.
- 2 Adjust the hour.

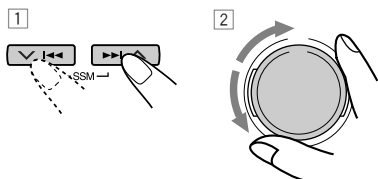

- 3 Set the minute.

- 1 Select "CLOCK MIN."
- 2 Adjust the minute.

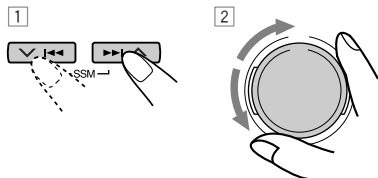

- 4 Press SEL (select) to finish the setting.



To check the current clock time while the unit is turned off, press DISP (D) (display).

The power turns on, the clock time is shown for 5 seconds, then the power turns off.

Changing the general settings (PSM)

You can change the items listed on the next page by using the PSM (Preferred Setting Mode) control.

Basic Procedure

- 1 Press and hold SEL (select) for more than 2 seconds so that one of the PSM items appears on the display. (See page 25.)



- 2 Select a PSM item you want to adjust. (See page 25.)



- 3 Adjust the PSM item selected.

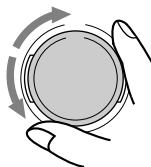

- 4 Repeat steps 2 and 3 to adjust the other PSM items if necessary.

- 5 Press SEL (select) to finish the setting.

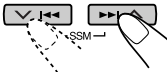
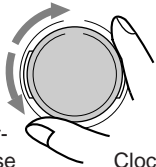

Preferred Setting Mode (PSM) items

<div style="display: flex; justify-content: space-around;"> <div style="text-align: center;"> 1  Hold. </div> <div style="text-align: center;"> 2  Select. </div> <div style="text-align: center;"> 3  Set. Counter-clockwise Clockwise </div> </div>		Factory-preset settings	See page		
CLOCK HOUR	Hour adjustment	Back	Advance	1:00	24
CLOCK MIN	Minute adjustment	Back	Advance		
EQ LINK	Sound control memory linkage	LINK OFF	LINK ON	LINK OFF	22
CLOCK DISP	Clock display	CLOCK OFF	CLOCK ON	CLOCK ON	26
LEVEL/EQ	Equalizer/Level indicator	EQ ONLY ↔ LEVEL+EQ ↙ ↗ LEVEL ONLY		LEVEL+EQ	26
DIMMER	Dimmer mode	AUTO ↔ OFF ↙ ↗ ON ↕		AUTO	26
BEEP SW	Key-touch tone	BEEP OFF	BEEP ON	BEEP ON	26
P.AMP SW	Power amplifier switch	P.AMP OFF	P.AMP ON	P.AMP ON	26
CONTRAST	Display contrast	CONTRAST 1 – CONTRAST 10		CONTRAST 5	26
SCROLL	Scroll mode	ONCE ↔ AUTO ↙ ↗ OFF ↕		ONCE	26
CUTOFF F	Subwoofer cutoff frequency	FREQ LOW ↔ FREQ MID ↙ ↗ FREQ HIGH		FREQ MID	26
AREA	Tuner interval	AREA US	AREA EU	AREA US	26
LINE ADJ	Line input level adjustment	L.ADJ 00 – L.ADJ 05		L.ADJ 00	27
AUX ADJ	Auxiliary input level adjustment	A.ADJ 00 – A.ADJ 05		A.ADJ 00	27
KEY SELECT	External key-operation mode selection	DVD ↔ VCR ↙ ↗ OFF ↕		DVD	27
IF FILTER	Intermediate frequency filter	WIDE	AUTO	AUTO	27
DEMO MODE	Demonstration mode	DEMO OFF	DEMO ON	DEMO ON	27
TAG DISP	Tag display	TAG OFF	TAG ON	TAG ON	27

- Press SEL (select) to finish the setting.



To set the clock display – CLOCK DISP

You can set the clock to be shown on the display when the unit is turned on.

When shipped from the factory, the clock is set to be shown on the display.

- **CLOCK ON:** Clock display is turned on.
- **CLOCK OFF:** Clock display is turned off.

To select the level meter – LEVEL/EQ

You can select the level display according to your preference.

When shipped from the factory, this mode is set to “LEVEL+EQ.”

- **EQ ONLY:** Equalizer pattern is displayed.
- **LEVEL+EQ:** Equalizer pattern is displayed along with audio level meter.
- **LEVEL ONLY:** Audio Level meter illuminates upward and downward from center.

To select the dimmer mode – DIMMER

When you turn on the car headlights, the display automatically dims (Auto Dimmer).

When shipped from the factory, Auto Dimmer mode is activated.

- **AUTO:** Activates Auto Dimmer.
- **OFF:** Cancels Auto Dimmer.
- **ON:** Always dims the display.

Note:

Auto Dimmer equipped for this unit may not work correctly on some vehicles, particularly on those having a control dial for dimming.

In this case, set the dimmer mode to “ON” or “OFF.”

To turn on/off the key-touch tone – BEEP SW

You can deactivate the key-touch tone if you do not want it to beep each time you press a button.

When shipped from the factory, the key-touch tone is activated.

- **BEEP ON:** Activates the key-touch tone.
- **BEEP OFF:** Deactivates the key-touch tone.

To turn on/off the power amplifier switch – P. AMP SW

You can switch off the built-in amplifier and send the audio signals only to the external amplifier(s) to get clear sounds and to prevent internal heat buildup inside this unit.

When shipped from the factory, the power amplifier switch is turned on so that the built-in amplifier works.

- **P. AMP ON:** Select this mode when not using external amplifier(s).
- **P. AMP OFF:** Select this mode when using external amplifier(s).

To adjust the display contrast level – CONTRAST

You can adjust the display contrast level among 1 (dark) to 10 (bright). When shipped from the factory, the display contrast level is set at level 5.

To select the scroll mode – SCROLL

You can select the scroll mode for the disc information if it consists of more than 10 characters.

When shipped from the factory, Auto Scroll mode is set to “ONCE.”

- **ONCE:** Scrolls only once.
- **AUTO:** Repeats the scroll (5-second intervals in between).
- **OFF:** Cancels Auto Scroll.

Note:

Even if the scroll mode is set to “OFF,” you can scroll the display by pressing DISP (D) for more than 1 second.

To select the subwoofer cutoff frequency – CUTOFF F

When a subwoofer is connected to this unit, select an appropriate cutoff frequency level for your subwoofer.

When shipped from the factory, the subwoofer cutoff frequency is set to “FREQ MID.”

- **FREQ LOW:** Frequencies higher than 50 Hz are cut off to the subwoofer.
- **FREQ MID:** Frequencies higher than 80 Hz are cut off to the subwoofer.
- **FREQ HIGH:** Frequencies higher than 120 Hz are cut off to the subwoofer.

To change the AM/FM channel intervals – AREA

When this unit is shipped from the factory, the channel intervals are set to 10 kHz for AM and 200 kHz for FM (AREA US settings).

You will have to change the channel intervals when using this unit in an area other than North America and South America.

- **AREA EU:** Select this when using this unit in an area other than North and South America. (9 kHz for AM and 50 kHz (for manual tuning) / 100 kHz (for searching) for FM)
- **AREA US:** Select this when using this unit in North or South America. (10 kHz for AM and 200 kHz for FM)

Note:

If the channel intervals settings are changed, the names assigned to the stations will be erased from memory. To reassign the names, see "Assigning names to the sources" on pages 28.

To adjust the line input level – LINE ADJ

Adjust the line input level properly when an external component is connected to the LINE IN plugs.

When shipped from the factory, the line input level is set at level 00.

If the input level of the connected component is not high enough, increase the input level properly. Without adjusting the line input level, you may be surprised at a loud sound when you change the source from the external component to another source.

To adjust the auxiliary input level**– AUX ADJ**

Adjust the auxiliary input level properly when an external component is connected to the MP3 INPUT jack.

When shipped from the factory, the auxiliary input level is set at level 00.

If the input level of the connected component is not high enough, increase the input level properly. Without adjusting the line input level, you may be surprised at a loud sound when you change the source from the external component to another source.

To select the target component to operate through this receiver – KEY SELECT

You can operate either JVC's DVD player or VCR through this receiver, by using the number buttons on the control panel.

When shipped from the factory, these number buttons are set to be used for the DVD operations. To use these number buttons on the control panel for DVD or VCR operations, see page 32.

To change the FM tuner selectivity – IF FILTER

In some areas, adjacent stations may interfere with each other. If this interference occurs, noise may be heard. This unit has been preset to automatically reduce this interference noise ("AUTO") when shipped from the factory.

- **AUTO:** When this type of interference occurs, this unit automatically increases the tuner selectivity so that interference noise will be reduced. (But the stereo effect will also be lost.)
- **WIDE:** Subject to the interference from adjacent stations, but sound quality will not be degraded and the stereo effect will not be lost.

To turn the demo mode on or off – DEMO MODE

You can turn the demo mode on or off. When shipped from the factory, "DEMO ON" is selected.

- **DEMO ON:** Turns the demo mode on. The demonstration will start automatically if no sound comes in for 3 minutes.
- **DEMO OFF:** Turns the demo mode off.

Note:

If the unit has been reset (and the power is on), demonstration will start if no sound comes in for about 10 seconds.

To turn the tag display on or off – TAG DISP

An MP3 file can contain file information called "ID3 Tag" where its album name, performer, track title, etc. are recorded.

There are two versions—ID3v1 (ID3 Tag version 1) and ID3v2 (ID3 Tag version 2). This unit is compatible only with ID3v1.

When shipped from the factory, "TAG ON" is selected.

- **TAG ON:** Turns on the ID3 tag display while playing MP3 files.
* If an MP3 file does not have ID3 tags, directory and file name appear.

Note:

If you change the setting from "TAG OFF" to "TAG ON" while playing an MP3 file, the tag display will be activated when the next file starts playing.

- **TAG OFF:** Turns off the ID3 tag display while playing MP3 files. (Only the directory name and file name can be shown.)

Assigning names to the sources

You can assign names to station frequencies, CDs and the external components. After assigning a name, it will appear on the display when you select the source.

Sources	Maximum number of the characters
Station frequencies	up to 10 characters (up to 30 station frequencies including both FM and AM)
CDs*	up to 32 characters (up to 40 discs)
External components (LINE INPUT and AUX INPUT)	up to 10 characters

* You cannot assign a name to a CD Text or an MP3 disc.

1 Select a source you want to assign a name to.

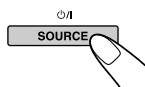

Each time you press the button, the source changes as described on page 7.

2 Press and hold SEL (select) for more than 2 seconds while pressing DISP (D).

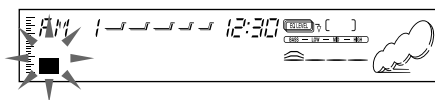
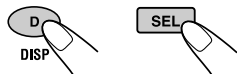

When you select an FM station as the source

3 Select the character set you want while "■" is flashing.



Each time you press the button, the character set changes as follows:

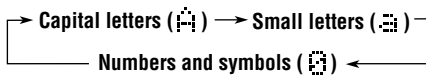

4 Select a character.

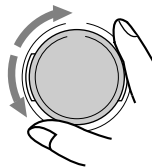

About the available characters, see page 35.

5 Move the cursor to the next (or previous) character position.

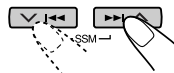

6 Repeat steps 3 to 5 until you finish inputting the name.

7 Finish the procedure while the last selected character is flashing.



To erase the input characters

Insert spaces using the same procedure described above.

Notes:

- When you try to assign a name to the 41st disc, "NAME FULL" appears on the display. (In this case, delete unwanted names before assignment.)
- When the CD changer is connected, you can assign names to discs in the CD changer. These names can also be shown on the display if you insert the discs in this unit.

Changing the control panel angle

You can change the angle of the control panel to four positions.

Adjust the angle to the position you want.



Each time you press the button, the panel angle changes as follows:

CAUTION:

NEVER insert your finger between the control panel and the unit, as it may get caught or hurt.

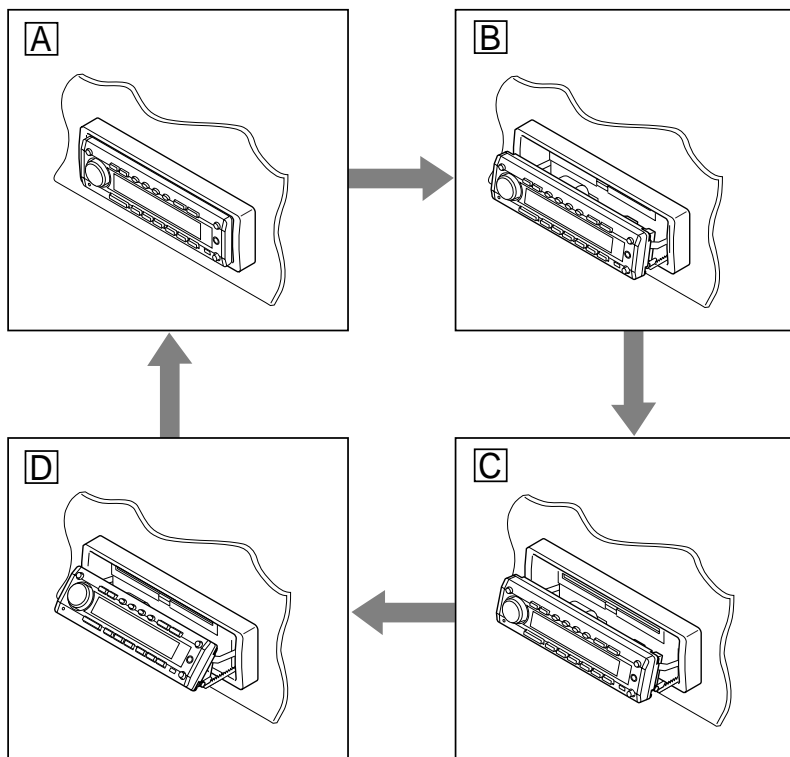
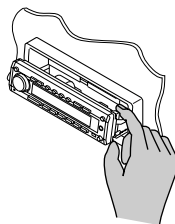

When using the remote controller

Press ANGLE ▼ repeatedly. Each time you press the button, the control panel changes its angle — **A**, **B**, **C**, then **D** positions in sequence.

To restore the control panel to its original position

Press ANGLE ▲ repeatedly. Each time you press the button, the control panel changes its angle in reverse — **D**, **C**, **B**, then **A** positions in sequence.

Detaching the control panel

You can detach the control panel when leaving the car.

When detaching or attaching the control panel, be careful not to damage the connectors on the back of the control panel and on the panel holder.

Detaching the control panel

Before detaching the control panel:

- Be sure to turn off the power
- Be sure to return the control panel to its original position

1 Unlock the control panel.

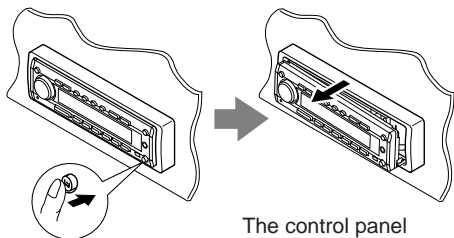

The control panel comes out toward you.

2 Move the control panel to the right, then pull it out of the unit.

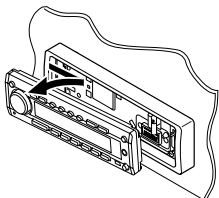

3 Put the detached control panel into the provided case.

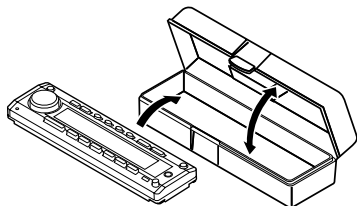

Attaching the control panel

1 Insert the left side of the control panel into the groove on the panel holder.

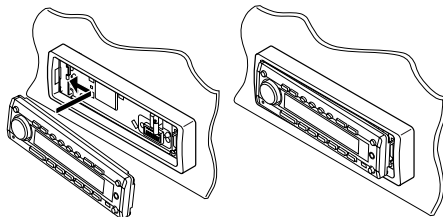

2 Press the right side of the control panel to fix it to the panel holder.

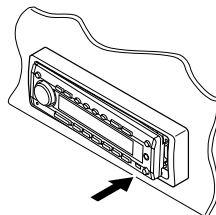

Note on cleaning the connectors:

If you frequently detach the control panel, the connectors will deteriorate.

To minimize this possibility, periodically wipe the connectors with a cotton swab or cloth moistened with alcohol, being careful not to damage the connectors.

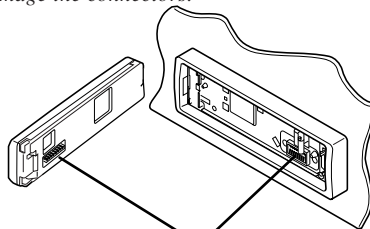

Connectors

EXTERNAL COMPONENT OPERATIONS

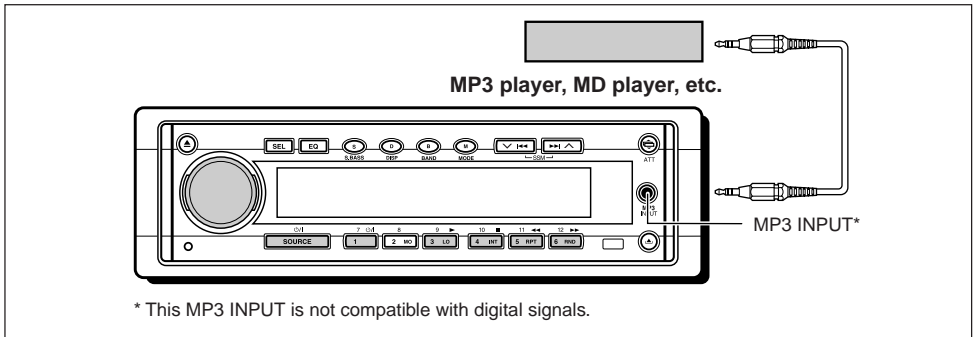

Playing external components

You can connect two external components to this unit.

Connect one to the MP3 INPUT jack on the control panel, and the other to the LINE IN plugs on the rear.

You can connect a JVC DVD player or VCR to the LINE IN plugs.

You can operate a JVC DVD player or VCR through this receiver using the number buttons on the control panel.

When you operate the VCR, you have to change the operation mode of the number buttons from the DVD operation mode to the VCR operation mode. (See "To select the target component to operate through this receiver – KEY SELECT" on page 27.)

If the input level of the external components is not high enough, increase the input level properly.

Without adjusting the input level, you may be surprised at a loud sound when you change the source from the external components to another. (See "To adjust the line input level – LINE ADJ" and "To adjust the auxiliary input level – AUX ADJ" on page 27.)

1 Select the external component (AUX INPUT or LINE INPUT).

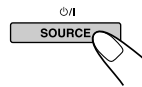

When you select a source, the power automatically comes on.

Each time you press the button, the source changes as described on page 7.



AUX INPUT: To select the component connected to the MP3 INPUT jack on the control panel

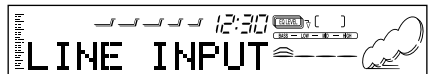

LINE INPUT: To select the component connected to the LINE IN plugs on the rear



2 Turn on the connected component and start playing the source.

- If connecting a JVC DVD player or VCR, you can perform the following operations:

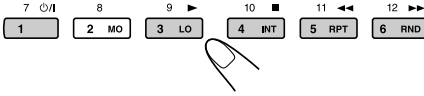

When connecting a DVD player:

- ⏻/⏻ : Turns on and off the power.
- ▶ : Starts playback.
- ▶▶ : • Fast-forward the track when pressed and held.
- Skip to the beginning of the next tracks when pressed briefly.
- ◀◀ : • Reverses the track when pressed and held.
- Go back to the beginning of the current track when pressed briefly.
- Go back to the beginning of the previous tracks when pressed consecutively.
- : Stops playback.

Note:

When you press the above buttons, the display shows “DVD” and its operation mode (such as ▶, ■).

When connecting a VCR:

- ⏻/⏻ : Turns on and off the power.
- ▶ : Starts playback.
- ▶▶ : Fast-winds a tape when pressed and held.
- ◀◀ : Rewinds a tape when pressed and held.
- : Stops playback.

Note:

When you press the above buttons, the display shows “VCR” and its operation mode (such as ▶, ■).

3 Adjust the volume.

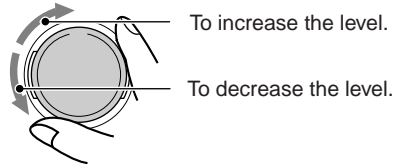

4 Adjust the sound you want. (See page 21.)

CD CHANGER OPERATIONS

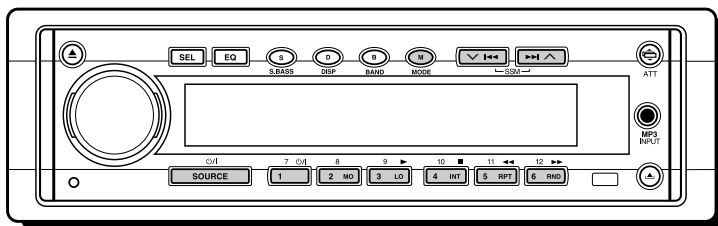

We recommend that you use one of the CH-X series with your unit.

If you have another CD automatic changer, consult your JVC car audio dealer for connections.

- For example, if your CD automatic changer is one of the KD-MK series, you need a cord (KS-U15K) for connecting it to this unit.

To fast-forward or reverse the track

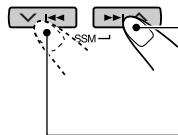

Press and hold **▶▶ ▲**, while playing a disc, to fast-forward the track.

Press and hold **▼ ◀◀**, while playing a disc, to reverse the track.

To go to the next track or the previous tracks

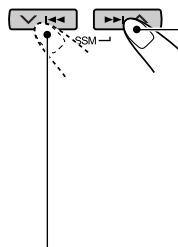

Press **▶▶ ▲** briefly, while playing a disc, to go ahead to the beginning of the next track. Each time you press the button consecutively, the beginning of the next track is located and played back.

Press **▼ ◀◀** briefly, while playing a disc, to go back to the beginning of the current track. Each time you press the button consecutively, the beginning of the previous tracks is located and played back.

Before operating your CD automatic changer:

- Refer also to the Instructions supplied with your CD changer.
- If no discs are in the magazine of the CD changer or the discs are inserted upside down, "NO DISC" will appear on the display. If this happens, remove the magazine and set the discs correctly.
- If "RESET 1" – "RESET 8" appears on the display, something is wrong with the connection between this unit and the CD changer. If this happens, check the connection and make sure the cords are connected firmly. Then, press the reset button of the CD changer.

Playing CDs

Select the CD automatic changer (CD CHANGER).

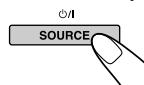

When you select a source, the power automatically comes on.

Each time you press the button, the source changes as described on page 7.

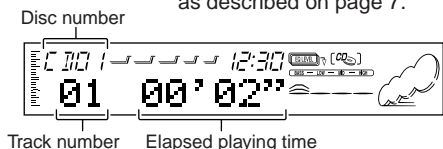

Track number Elapsed playing time



To go to a particular disc directly

Press the number button corresponding to the disc number to start its playback (while the CD changer is playing).



- To select a disc number from 1 – 6:
Press 1 (7) – 6 (12) briefly.
- To select a disc number from 7 – 12:
Press and hold 1 (7) – 6 (12) for more than 1 second.

Disc number

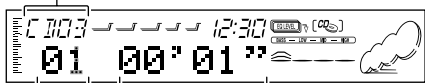

Track number Elapsed playing time

Ex.: When disc number 3 is selected

Selecting CD playback modes

To play back tracks at random (Random Play)

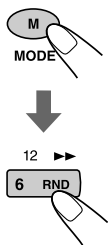

- 1 Press MODE (M) while playing a disc. The unit enters the functions mode.
- 2 Press RND (random) while still in the functions mode, so that the RND indicator lights up on the display. Then, each time you press RND, the random play mode changes as follows:



Mode	RND Indicator	Plays at random
RND 1	Lights	All tracks of the current disc, then the tracks of the next disc and so on.
RND 2	Flashes	All tracks of all discs inserted in the magazine.

To play back tracks repeatedly (Repeat Play)



- 1 Press MODE (M) while playing a disc. The unit enters the functions mode.
- 2 Press RPT (repeat) while still in the functions mode, so that the RPT indicator lights up on the display. Then, each time you press RPT, the repeat play mode changes as follows:



Mode	RPT Indicator	Plays repeatedly
RPT 1	Lights	The current track (or specified track).
RPT 2	Flashes	All tracks of the current disc (or specified disc).

To play back only intros (Intro scan)

You can play back the first 15 seconds of each track sequentially.

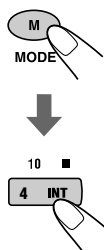

- 1 Press MODE (M) while playing a disc. The unit enters the functions mode.
- 2 Press INT (intro scan) while still in the functions mode, so that "INT" appears on the display. Then, each time you press INT, the intro scan mode changes as follows:



Mode	Indicator	Plays the beginnings (15 seconds)
INT 1	Track number flashes	Of all tracks on all inserted discs.
INT 2	Disc number flashes	Of the first track on each inserted disc.



Sound modes (preset value settings)

The list below shows the preset value settings for each sound mode. If you have changed their settings, you can reset to the factory settings by reassigning the preset values below. (See page 23 for reassignment procedures.)

Indication	Preset equalizing values							
	FREQ.	WIDTH	LOW LEVEL	FREQ.	WIDTH	MID LEVEL	FREQ.	HIGH LEVEL
FLAT	50 Hz	1	00	700 Hz	1	00	8 kHz	00
Hard Rock	80 Hz	2	+03	700 Hz	1	00	8 kHz	+02
R & B	80 Hz	3	+03	2 kHz	2	+01	12 kHz	+03
POP	120 Hz	1	+02	2 kHz	2	+01	12 kHz	+02
JAZZ	80 Hz	1	+03	1 kHz	1	+01	8 kHz	+03
DanceMusic	50 Hz	2	+04	700 Hz	1	-02	8 kHz	+01
Country	50 Hz	4	+02	700 Hz	1	00	12 kHz	+02
Reggae	80 Hz	1	+03	2 kHz	2	+02	12 kHz	+02
Classic	120 Hz	1	+03	1 kHz	1	00	8 kHz	+02
User 1	50 Hz	1	00	700 Hz	1	00	8 kHz	00
User 2	50 Hz	1	00	700 Hz	1	00	8 kHz	00
User 3	50 Hz	1	00	700 Hz	1	00	8 kHz	00

Available characters

You can use the following characters to assign names to CDs, radio stations, and external components. (See page 28.)

Capital letters

A	B	C	D	E
F	G	H	I	J
K	L	M	N	O
P	Q	R	S	T
U	V	W	X	Y
Z	space			

Small letters

a	b	c	d	e
f	g	h	i	j
k	l	m	n	o
p	q	r	s	t
u	v	w	x	y
z	space			



Numbers and symbols

0	1	2	3	4
5	6	7	8	9
!	"	#	\$	%
&	'	()	*
+	,	-	.	/
:	;	<	=	>
?	@	_	`	space



TROUBLESHOOTING

What appears to be trouble is not always serious. Check the following points before calling a service center.

	Symptoms	Causes	Remedies
General Playback	• Disc cannot be played back.	Disc is inserted upside down. ("DISC ERR" appears on the display.)	Insert the disc correctly.
	• Sound is sometimes interrupted.	You are driving on rough roads.	Stop playback while driving on rough roads.
		Disc is scratched.	Change the disc.
		Connections are incorrect.	Check the cords and connections.
	• Sound cannot be heard from the speakers.	The volume level is set to the minimum level.	Adjust it to the optimum level.
		Connections are incorrect.	Check the cords and connections.
	• "DISC ERR" appears on the display.	Contents on the disc are not compatible with the unit.	Change the disc.
• "NO DISC" or "EJECT ERR" appears on the display and disc cannot be ejected. • No message appears on the display but disc cannot be ejected.	The unit may function incorrectly.	While pressing  , press and hold  for more than 2 seconds. (Be careful not to drop the disc when ejecting.)	
• This unit or CD changer does not work at all.	The built-in microcomputer may function incorrectly due to noise, etc.	Press the reset button on the control panel. (See page 2.)	
FM/AM	• SSM (Strong-station Sequential Memory) automatic preset does not work.	Signals are too weak.	Store stations manually.
	• Static noise while listening to the radio.	The antenna is not connected firmly.	Connect the antenna firmly.
CD Changer	• "NO DISC" appears on the display.	No disc is in the magazine.	Insert a disc.
	• "RESET 8" appears on the display.	This unit is not connected to a CD changer correctly.	Connect this unit and the CD changer correctly and press the reset button of the CD changer.
	• "RESET 1" – "RESET 7" appears on the display.	_____	Press the reset button of the CD changer.



Symptoms	Causes	Remedies
<ul style="list-style-type: none"> Disc cannot be played back. 	No MP3 files are recorded on the disc.	Change the disc.
	MP3 files do not have the extension code—mp3 in their file names.	Add the extension code—mp3 to their file names.
	MP3 files are not recorded in the format compliant with ISO 9660 Level 1 or 2.	Change the disc. (Record MP3 files using a compliant application.)
<ul style="list-style-type: none"> Noise is generated. 	The file played back is not an MP3 file (although it has the extension code—mp3).	Skip to another file or change the disc. (Do not add the extension code—mp3 to non-MP3 files.)
<ul style="list-style-type: none"> A longer readout time is required (“FILE CHECK” keeps flashing on the display). 	Readout time varies due to the complexity of the directory/file configuration.	Do not use too many hierarchies and directories. Also, do not record any other types of audio tracks together with MP3 files.
<ul style="list-style-type: none"> Files cannot be played back as you have intended them to play. 	Playback order is determined when the files are recorded.	_____
<ul style="list-style-type: none"> Elapsed playing time is not correct. 	This sometimes occurs during play. This is caused by how the files are recorded on the disc.	_____
<ul style="list-style-type: none"> “MP3” flashes on the display. 	The current directory does not contain any MP3 files.	Select another directory.
<ul style="list-style-type: none"> Correct characters are not displayed. (Tag Display, e.g. album name) 	This unit can only display alphabets (capital: A–Z, small: a–z) and numbers.	_____

MP3 Playback



Handling discs

This unit has been designed to reproduce the discs bearing the following marks.



You can also play back your original CD-Rs (Recordable) and CD-RWs (Rewritable) either in audio CD format or in MP3 format.

How to handle discs

When removing a disc from its case, press down the center holder of the case and lift the disc out, holding it by the edges.

- Always hold the disc by the edges. Do not touch its recording surface.

When storing a disc into its case, gently insert the disc around the center holder (with the printed surface facing up).

- Make sure to store discs into the cases after use.

Center holder

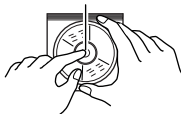

To keep discs clean

A dirty disc may not play correctly. If a disc does become dirty, wipe it with a soft cloth in a straight line from center to edge.



To play new discs

New discs may have some rough spots around the inner and outer edges. If such a disc is used, this unit may reject the disc.

To remove these rough spots, rub the edges with a pencil or ball-point pen, etc.

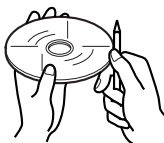

Moisture condensation

Moisture may condense on the lens inside the unit in the following cases:

- After starting the heater in the car.
 - If it becomes very humid inside the car.
- Should this occur, the unit may malfunction. In this case, eject the disc and leave the unit turned on for a few hours until the moisture evaporates.

CAUTIONS:

- Do not insert 8 cm (3 3/16") discs (single CDs) into the loading slot. (Such discs cannot be ejected.)
- Do not insert any disc of unusual shape — like a heart or flower; otherwise, it will cause a malfunction.
- Do not expose discs to direct sunlight or any heat source or place them in a place subject to high temperature and humidity. Do not leave them in a car.
- Do not use any solvent (for example, conventional record cleaner, spray, thinner, benzine, etc.) to clean discs.

When playing a CD-R or CD-RW

You can play back your original CD-Rs or CD-RWs recorded in audio CD format or in MP3 format. (However, they may not be played back depending on their characteristics or recording conditions.)

- User-edited CD-Rs (Recordable) and CD-RWs (Rewritable), where audio CD tracks are recorded, can be played back only if they are already "finalized."
- Before playing back CD-Rs or CD-RWs, read their instructions or cautions carefully.
- Some CD-Rs or CD-RWs may not be played back on this unit because of their disc characteristics, damage or stain on them, or if the player's lens is dirty.
- CD-Rs or CD-RWs are susceptible to high temperatures or high humidity; so do not leave them inside your car.
- CD-RWs may require a longer readout time. (This is caused by the fact that the reflectance of CD-RWs is lower than for regular CDs.)

About mistracking:

Mistracking may result from driving on extremely rough roads. This does not damage the unit and the disc, but will be annoying. We recommend that you stop disc playback while driving on such rough roads.

AUDIO AMPLIFIER SECTION

Maximum Power Output:

Front: 50 W per channel

Rear: 50 W per channel

Continuous Power Output (RMS):

Front: 19 W per channel into 4 Ω , 40 Hz to 20 000 Hz at no more than 0.8 % total harmonic distortion.

Rear: 19 W per channel into 4 Ω , 40 Hz to 20 000 Hz at no more than 0.8 % total harmonic distortion.

Load Impedance: 4 Ω (4 Ω to 8 Ω allowance)

Equalizer Control Range:

LOW: ± 12 dB (50 Hz, 80 Hz, 120 Hz)

MID: ± 12 dB (700 Hz, 1 kHz, 2 kHz)

HIGH: ± 12 dB (8 kHz, 12 kHz)

Frequency Response: 40 Hz to 20 000 Hz

Signal-to-Noise Ratio: 70 dB

Line-In Level/Impedance:

LINE IN: 1.5 V/20 k Ω load

MP3 INPUT: 3.5 mm dia. stereo mini jack (analog)

Line-Out Level/Impedance:

4.0 V/20 k Ω load (full scale)

Output Impedance: 1 k Ω

TUNER SECTION

Frequency Range:

FM: 87.5 MHz to 107.9 MHz
(with channel interval set to 200 kHz)
87.5 MHz to 108.0 MHz

(with channel interval set to 50 kHz)

AM: 530 kHz to 1 710 kHz
(with channel interval set to 10 kHz)
531 kHz to 1 602 kHz
(with channel interval set to 9 kHz)

[FM Tuner]

Usable Sensitivity: 11.3 dBf (1.0 μ V/75 Ω)

50 dB Quieting Sensitivity:

16.3 dBf (1.8 μ V/75 Ω)

Alternate Channel Selectivity (400 kHz):

65 dB

Frequency Response: 40 Hz to 15 000 Hz

Stereo Separation: 35 dB

Capture Ratio: 1.5 dB

[AM Tuner]

Sensitivity: 20 μ V

Selectivity: 35 dB

CD PLAYER SECTION

Type: Compact disc player

Signal Detection System: Non-contact optical pickup (semiconductor laser)

Number of channels: 2 channels (stereo)

Frequency Response: 5 Hz to 20 000 Hz

Dynamic Range: 98 dB

Signal-to-Noise Ratio: 102 dB

Wow and Flutter: Less than measurable limit

MP3 decoding format: MPEG1/2 Audio Layer 3

Max. Bit Rate: 320 Kbps

GENERAL

Power Requirement:

Operating Voltage: DC 14.4 V

(11 V to 16 V allowance)

Grounding System: Negative ground

Allowable Operating Temperature:

0°C to +40°C (32°F to 104°F)

Dimensions (W x H x D):

Installation Size:

182 mm x 52 mm x 161 mm

(7-3/16" x 2-1/16" x 6-3/8")

Panel Size: 188 mm x 58 mm x 17 mm

(7-7/16" x 2-5/16" x 11/16")

Mass: 1.8 kg (4.0 lbs) (excluding accessories)

Design and specifications subject to change without notice.

If a kit is necessary for your car, consult your telephone directory for the nearest car audio speciality shop.



JVC

MOBILE
ENTERTAINMENT

<http://www.jvcmobile.com>

Visit us on-line for

Technical Support & Customer Satisfaction Survey.

US RESIDENTS ONLY

**Having TROUBLE with operation?
Please reset your unit**

**Refer to page of How to Reset
Still having trouble??**

USA ONLY

Call 1-800-252-5722

<http://www.jvcservice.com>

We can help you!

JVC

VICTOR COMPANY OF JAPAN, LIMITED

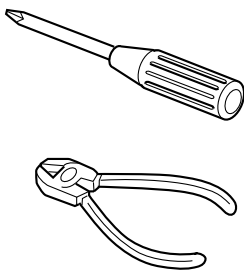

ENGLISH

- This unit is designed to operate on 12 V DC, NEGATIVE ground electrical systems.

INSTALLATION (IN-DASH MOUNTING)

- The following illustration shows a typical installation. However, you should make adjustments corresponding to your specific car. If you have any questions or require information regarding installation kits, consult your JVC car audio dealer or a company supplying kits.

ESPAÑOL

- Esta unidad está diseñada para funcionar con 12 V de CC, con sistemas eléctricos de masa NEGATIVA.

INSTALACION (MONTAJE EN EL TABLERO DE INSTRUMENTOS)

- La siguiente ilustración muestra una instalación típica. Sin embargo usted deberá efectuar los ajustes correspondientes a su automóvil. Si tiene alguna pregunta o necesita información acerca de las herramientas para instalación, consulte con su concesionario de JVC de equipos de audio para automóviles o a una compañía que suministra tales herramientas.

FRANÇAIS

- Cet appareil est conçu pour fonctionner sur des sources de courant continu de 12 V à masse NEGATIVE.

INSTALLATION (MONTAGE DANS LE TABLEAU DE BORD)

- L'illustration suivante est un exemple d'installation typique. Cependant, vous devez faire les ajustements correspondant à votre voiture particulière. Si vous avez des questions ou avez besoin d'information sur des kits d'installation, consultez votre revendeur d'autoradios JVC ou une compagnie d'approvisionnement.

- Before mounting:** Press (Control Panel Release button) to detach the control panel if already attached.
* When shipped from the factory, the control panel is packed in the hard case.
- Remove the trim plate.
- Remove the sleeve after disengaging the sleeve locks.
 - Stand the unit.
Note: When you stand the unit, be careful not to damage the fuse on the rear.
 - Insert the 2 handles between the unit and the sleeve, as illustrated, to disengage the sleeve locks.
 - Remove the sleeve.
Note: Be sure to keep the handles for future use after installing the unit.
- Install the sleeve into the dashboard.
* After the sleeve is correctly installed in the dashboard, bend the appropriate tabs to hold the sleeve firmly in place, as illustrated.
- Fix the mounting bolt to the rear of the unit's body and place the rubber cushion over the end of the bolt.
- Do the required electrical connections.
- Slide the unit into the sleeve.
- Attach the trim plate.
- Attach the control panel.

- Antes de instalar:** Pulse (botón de liberación del panel de control) para desenganchar el panel de control, si ya está fijado.
* El panel de control se expide de fábrica dentro del estuche duro.
- Retire la placa de guarnición.
- Retire la cubierta después de desenganchar los retenes de la cubierta.
 - Ponga la unidad vertical.
Nota: Al poner la unidad vertical, tenga cuidado de no dañar el fusible provisto en la parte posterior.
 - Inserte las dos manijas entre la unidad y la cubierta tal como en la ilustración y desenganche los retenes de la cubierta.
 - Retire la cubierta.
Nota: Después de instalar la unidad, asegúrese de guardar las manijas para uso futuro.
- Instale la cubierta en el tablero de instrumentos.
* Después de que la cubierta esté correctamente instalada en el tablero de instrumentos, doble las lengüetas correspondientes para sostener la cubierta firmemente en su lugar, tal como se muestra.
- Fije el perno de montaje en la parte trasera del cuerpo de la unidad y coloque el cojín de goma sobre el extremo del perno.
- Realice las conexiones eléctricas requeridas.
- Deslice la unidad dentro de la cubierta hasta que quede trabada.
- Coloque la placa de guarnición.
- Coloque el panel de control.

- Avant le montage:** Appuyer sur (déblocage du panneau de commande) pour éventuellement détacher le panneau de commande.
* Lorsque ce panneau de commande sort d'usine, il est rangé dans un étui de transport.
- Retirer la plaque d'assemblage.
- Libérer les verrous du manchon et retirer le manchon.
 - Poser l'appareil à la verticale.
Remarque: Lorsque vous mettez l'appareil à la verticale, faire attention de ne pas endommager le fusible situé sur l'arrière.
 - Insérer les 2 poignées entre l'appareil et le manchon comme indiqué pour désengager les verrous de manchon.
 - Retirer le manchon.
Remarque: S'assurer de garder les poignées pour une utilisation ultérieure, après l'installation de l'appareil.
- Installer le manchon dans le tableau de bord.
* Après installation correcte du manchon dans le tableau de bord, plier les bonnes pattes pour maintenir fermement le manchon en place, comme montré.
- Monter le boulon de montage sur l'arrière du corps de l'appareil puis passer l'amortisseur en caoutchouc sur l'extrémité du boulon.
- Réalisez les connexions électriques.
- Faites glisser l'appareil dans le manchon jusqu'à ce qu'il soit verrouillé.
- Attachez la plaque d'ajustage.
- Remonter le panneau de commande.

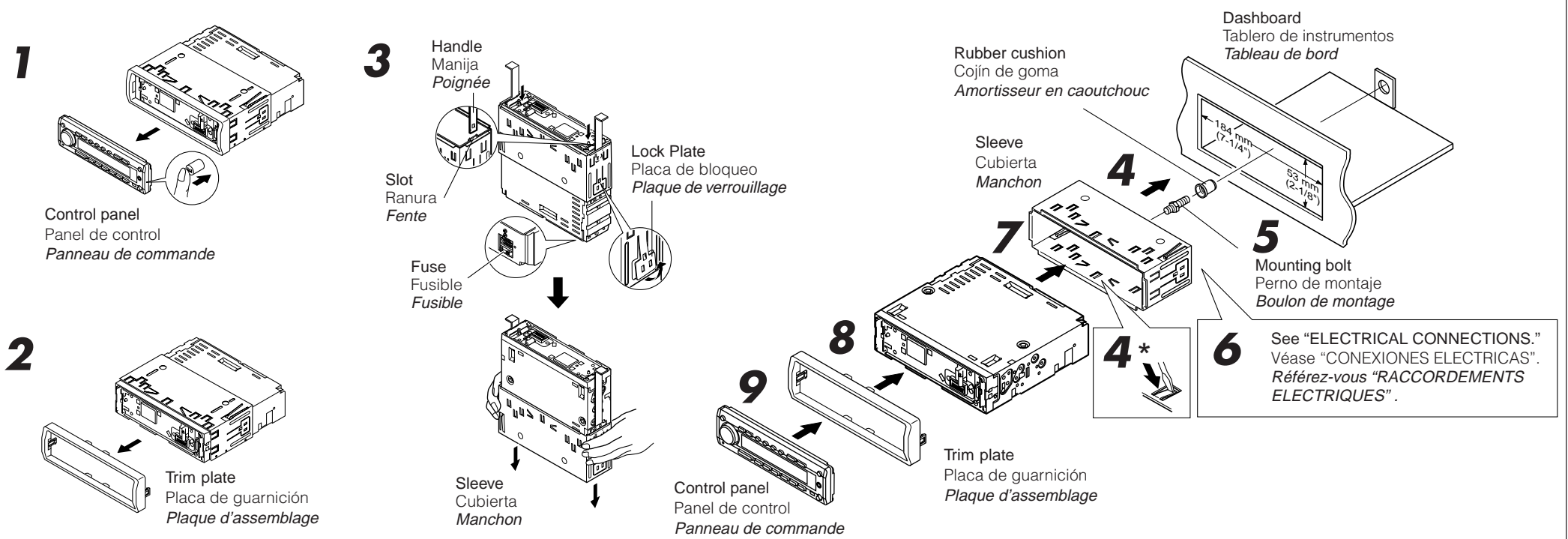

TROUBLESHOOTING

- The fuse blows.**
* Are the red and black leads connected correctly?
- Power cannot be turned on.**
* Is the yellow lead connected?
- No sound from the speakers.**
* Is the speaker output lead short-circuited?
- Sound is distorted.**
* Is the speaker output lead grounded?
* Are the "-" terminals of L and R speakers grounded in common?
- Unit becomes hot.**
* Is the speaker output lead grounded?
* Are the "-" terminals of L and R speakers grounded in common?

LOCALIZACION DE AVERIAS

- El fusible se quema.**
* ¿Están los conductores rojo y negro correctamente conectados?
- No es posible conectar la alimentación.**
* ¿Está el cable amarillo conectado?
- No sale sonido de los altavoces.**
* ¿Está el cable de salida del altavoz cortocircuitado?
- El sonido presenta distorsión.**
* ¿Está el cable de salida del altavoz conectado a masa?
* ¿Están los terminales "-" de los altavoces L y R conectados a una masa común?
- La unidad se calienta.**
* ¿Está el cable de salida del altavoz conectado a masa?
* ¿Están los terminales "-" de los altavoces L y R conectados a una masa común?

EN CAS DE DIFFICULTES

- Le fusible saute.**
* Les fils rouge et noir sont-ils raccordés correctement?
- L'appareil ne peut pas être mise sous tension.**
* Le fil jaune est-elle raccordée?
- Pas de son des enceintes.**
* Le fil de sortie de d'enceinte est-il court-circuité?
- Le son est déformé.**
* Le fil de sortie de d'enceinte est-il à la masse?
* Les bornes "-" des enceintes gauche et droit sont-elles mises ensemble à la masse?
- L'appareil devient chaud.**
* Le fil de sortie de d'enceinte est-il à la masse?
* Les bornes "-" des enceintes gauche et droit sont-elles mises ensemble à la masse?

- When using the optional stay
- Cuando emplea un soporte opcional
- Lors de l'utilisation du hauban en option

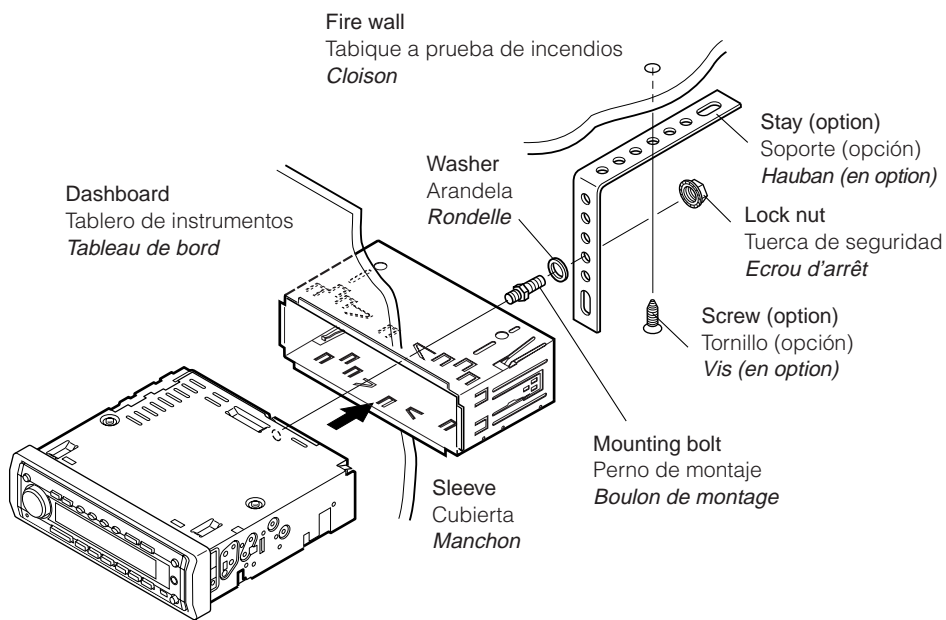

- When installing the unit without using the sleeve
- Instalación de la unidad sin utilizar la cubierta
- Lors de l'installation de l'appareil sans utiliser de manchon

In a Toyota for example, first remove the car radio and install the unit in its place.
En un Toyota por ejemplo, primero extraiga la radio del automóvil y luego instale la unidad en su lugar.

Par exemple dans une Toyota, retirer d'abord l'autoradio et installer l'appareil à la place.

Flat type screws (M5 x 6 mm)*
Tornillos tipo plano (M5 x 6 mm)*
Vis à tête plate (M5 x 6 mm)*

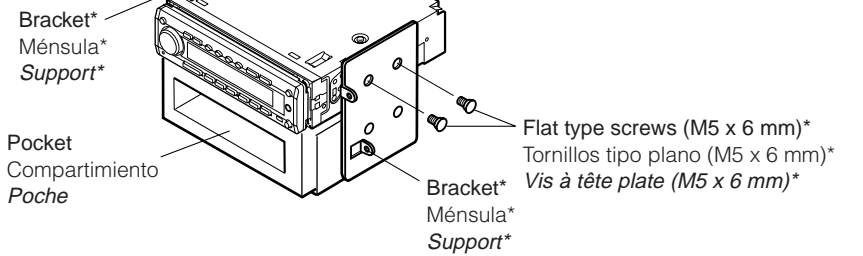

* Not included with this unit.
* No suministrado con esta unidad.
* Non fourni avec cet appareil.

Note: When installing the unit on the mounting bracket, make sure to use the 6 mm-long screws. If longer screws are used, they could damage the unit.

Nota: Cuando instala la unidad en la ménsula de montaje, asegúrese de utilizar los tornillos de 6 mm de longitud. Si se utilizan tornillos más largos, éstos pueden dañar la unidad.

Remarque: Lors de l'installation de l'appareil sur le support de montage, s'assurer d'utiliser des vis d'une longueur de 6 mm. Si des vis plus longues sont utilisées, elles peuvent endommager l'appareil.

Removing the unit

- Before removing the unit, release the rear section.
- 1** Remove the control panel.
- 2** Remove the trim plate.
- 3** Insert the 2 handles into the slots, as shown. Then, while gently pulling the handles away from each other, slide out the unit. (Be sure to keep the handles after installing it.)

Extracción de la unidad

- Antes de extraer la unidad, libere la sección trasera.
- 1** Extraiga el panel de control.
- 2** Retire la placa de guarnición.
- 3** Inserte las 2 manijas entre las ranuras, como se muestra. Luego, separe suavemente las manijas y extraiga la unidad. (Asegúrese de conservar las manijas después de instalarlo.)

Retrait de l'appareil

- Avant de retirer l'appareil, libérer la section arrière.
- 1** Retirer le panneau de commande.
- 2** Retirer la plaque d'assemblage.
- 3** Introduire les deux poignées dans les fentes, comme montré. Puis, tout en tirant doucement les poignées écartées, faire glisser l'appareil pour le sortir. (S'assurer de conserver les poignées après l'installation de l'appareil.)

1

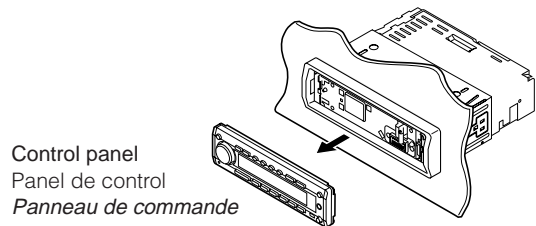

Control panel
Panel de control
Panneau de commande

2

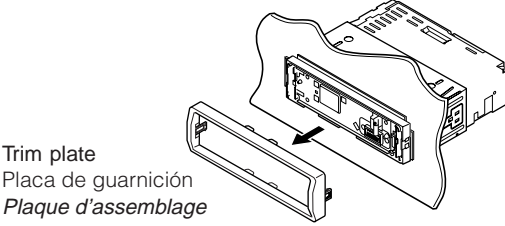

Trim plate
Placa de guarnición
Plaque d'assemblage

3

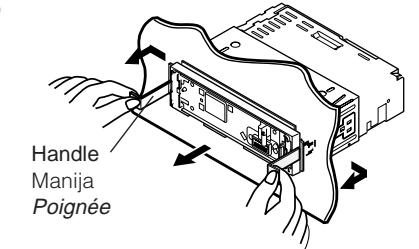

Handle
Manija
Poignée

Parts list for installation and connection

The following parts are provided with this unit.
After checking them, please set them correctly.

Hard case/Control panel
Estuche duro/Panel de control
Etui de transport/Panneau de commande

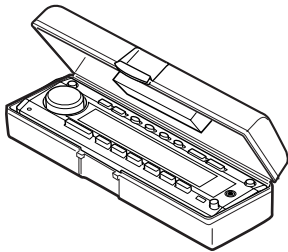

Power cord
Cordón de alimentación
Cordon d'alimentation

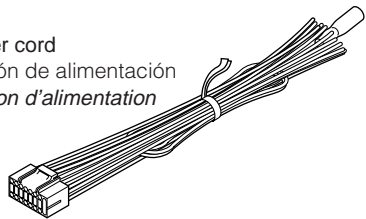

Handles
Manijas
Poignées

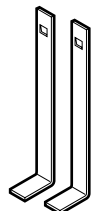

Lista de piezas para instalación y conexión

Con esta unidad se suministran las siguientes piezas.
Después de inspeccionarlas, colóquelas correctamente.

Sleeve
Cubierta
Manchon

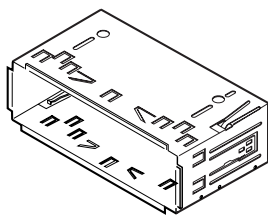

Washer (ø5)
Arandela (ø5)
Rondelle (ø5)



Lock nut (M5)
Tuerca de seguridad (M5)
Ecrou d'arrêt (M5)



Trim plate
Placa de guarnición
Plaque d'assemblage

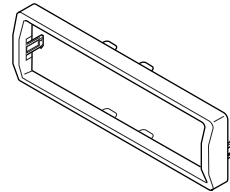

Mounting bolt (M5 x 20 mm)
Perno de montaje (M5 x 20 mm)
Boulon de montage (M5 x 20 mm)



Liste des pièces pour l'installation et raccordement

Les pièces suivantes sont fournies avec cet appareil.
Après vérification, veuillez les placer correctement.

Remote controller
Control remoto
Télécommande

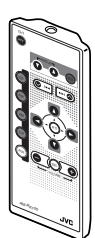

Battery
Pila
Pile



Rubber cushion
Cojín de goma
Amortisseur en caoutchouc



ELECTRICAL CONNECTIONS

To prevent short circuits, we recommend that you disconnect the battery's negative terminal and make all electrical connections before installing the unit. If you are not sure how to install this unit correctly, have it installed by a qualified technician.

Note:

This unit is designed to operate only on **12 V DC, NEGATIVE ground electrical systems**. If your vehicle does not have this system, a voltage inverter is required, which can be purchased at JVC car audio dealers.

- Replace the fuse with one of the specified rating. If the fuse blows frequently, consult your JVC car audio dealer.
- If noise is a problem...
This unit incorporates a noise filter in the power circuit. However, with some vehicles, clicking or other unwanted noise may occur. If this happens, connect the unit's **rear ground terminal** (see connection diagram) to the car's chassis using shorter and thicker cords, such as copper braiding or gauge wire. If noise still persists, consult your JVC car audio dealer.
- Maximum input of the speakers should be no more than 50 W at the rear and 50 W at the front, with an impedance of **4 Ω to 8 Ω**.
- **Be sure to ground this unit to the car's chassis.**
- The heat sink becomes very hot after use. Be careful not to touch it when removing this unit.

Heat sink
Sumidero térmico
Dissipateur de chaleur

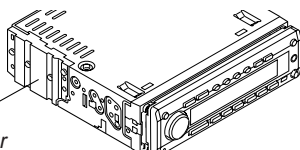

CONEXIONES ELECTRICAS

Para evitar cortocircuitos, recomendamos que desconecte el terminal negativo de la batería y que efectúe todas las conexiones eléctricas antes de instalar la unidad. Si usted no está seguro de cómo instalar correctamente la unidad, hágala instalar por un técnico cualificado.

Nota:

Esta unidad está diseñada para funcionar con **12 V de CC, con sistemas eléctricos de masa NEGATIVA** solamente. Si su vehículo no posee este sistema, será necesario un inversor de tensión, que puede ser adquirido en los concesionarios de JVC de equipos de audio para automóviles.

- Reemplace el fusible por uno con la corriente especificada. Si el fusible se quemase frecuentemente consulte con su concesionario de JVC de equipos de audio para automóviles.
- Si el ruido fuese un problema...
Esta unidad tiene un filtro de ruido en el circuito de alimentación. Sin embargo, en algunos vehículos, pueden producirse chasquidos u otros ruidos indeseados. En tal caso conecte el **terminal de tierra posterior** (véase diagrama de conexión) del receptor al chasis del automóvil, utilizando cordones más gruesos y cortos tales como alambre de cobre trenzado o de grueso calibre. Si el ruido persiste, consulte a su concesionario de JVC de equipos de audio para automóvil.
- La entrada máxima de los altavoces traseros no debe ser no más que 50 W en el trasero y 50 W en la frontal, con una impedancia de **4 Ω a 8 Ω**.
- **Asegúrese de conectar esta unidad a tierra en el chasis del automóvil.**
- El sumidero térmico estará muy caliente después del uso. Asegúrese de no tocarlo al desmontar esta unidad.

RACCORDEMENTS ELECTRIQUES

Pour éviter tout court-circuit, nous vous recommandons de débrancher la borne négative de la batterie et d'effectuer tous les raccordements électriques avant d'installer l'appareil. Si l'on n'est pas sûr de pouvoir installer correctement cet appareil, le faire installer par un technicien qualifié.

Remarque:

Cet appareil est conçu pour fonctionner sur des sources de courant continu de **12 V à masse NEGATIVE** seulement. Si votre véhicule n'offre pas ce type d'alimentation, il vous faut un convertisseur de tension, que vous pouvez acheter chez un revendeur d'autoradios JVC.

- Remplacer le fusible par un de la valeur précisée. Si le fusible saute souvent, consulter votre revendeur d'autoradios JVC.
- Si le bruit est un problème...
Cet appareil incorpore un filtre de bruit dans le circuit d'alimentation. Cependant, avec certains véhicules, quelques claquements ou autres bruits non désirés risquent de se produire. Si cela arrive, raccorder la **borne arrière de masse** de l'appareil au châssis de la voiture (voir le schéma de raccordement) en utilisant des cordons les plus gros et les plus courts possibles telle qu'une barre de cuivre ou une tresse. Si le bruit persiste, consulter votre revendeur d'autoradios JVC.
- La puissance admissible des enceintes devrait n'être pas plu qu'**50 W à l'arrière et à 50 W l'avant, avec une impédance de 4 Ω à 8 Ω**.
- **S'assurer de raccorder la mise à la masse de cet appareil au châssis de la voiture.**
- Le dissipateur de chaleur devient très chaud après usage. Faire attention de ne pas le toucher en retirant cet appareil.

A Typical Connections / Conexiones típicas / Raccordements typiques

Before connecting: Check the wiring in the vehicle carefully not to fail in connecting this unit. Incorrect connection may cause a serious damage to this unit.

Antes de la conexión: Verifique atentamente el conexionado del vehículo para no cometer errores al conectar esta unidad. Una conexión incorrecta podría producir daños graves en la unidad.

Avant de commencer la connexion: vérifiez attentivement le câblage du véhicule pour ne pas connecter incorrectement cet appareil. Une connexion incorrecte peut endommager sérieusement l'appareil.

- 1 Connect the colored leads of the power cord to the car battery, speakers and automatic antenna (if any) in the following sequence.
 - ① Black: ground
 - ② Yellow: to car battery (constant 12 V)
 - ③ Red: to an accessory terminal
 - ④ Blue with white stripe: to automatic antenna (200 mA max.)
 - ⑤ Orange with white stripe: to car light control switch
 - ⑥ Others: to speakers
- 2 Connect the antenna cord.
- 3 Finally connect the wiring harness to the unit.

- 1 Conecte los conductores de color del cable de alimentación a la batería del automóvil, altavoces y antena automática (si la hubiere) en la secuencia siguiente.
 - ① Negro: a tierra
 - ② Amarillo: a la batería del automóvil (12 V constantes)
 - ③ Rojo: a un terminal de accesorio
 - ④ Azul con rayas blancas: a la antena automática (200 mA máx.)
 - ⑤ Naranja con rayas blancas: al interruptor de control de las luces del automóvil
 - ⑥ Otros: a los altavoces
- 2 Conecte el cable de antena.
- 3 Por último, conecte a la unidad el cableado preformado.

- 1 Connectez les fils de couleur du cordon d'alimentation à la batterie de la voiture, aux enceintes et à l'antenne automatique (s'il y en a une) dans l'ordre suivant.
 - ① Noir: a la masse
 - ② Jaune: a la batterie de la voiture (12 V constant)
 - ③ Rouge: à la prise accessoire
 - ④ Bleu avec bande blanche: à l'antenne automatique (200 mA max.)
 - ⑤ Orange avec bande blanche: à l'interrupteur d'éclairage de la voiture
 - ⑥ Autres fils: aux enceintes
- 2 Connectez le cordon d'antenne.
- 3 Finalement, connectez le faisceau de fils à l'appareil.

Before connecting the CD changer, make sure that the unit is turned off. Antes de conectar el cambiador de CD, asegúrese de que la unidad esté apagada. Avant de connecter le changeur CD, s'assurer que l'unité est éteinte.

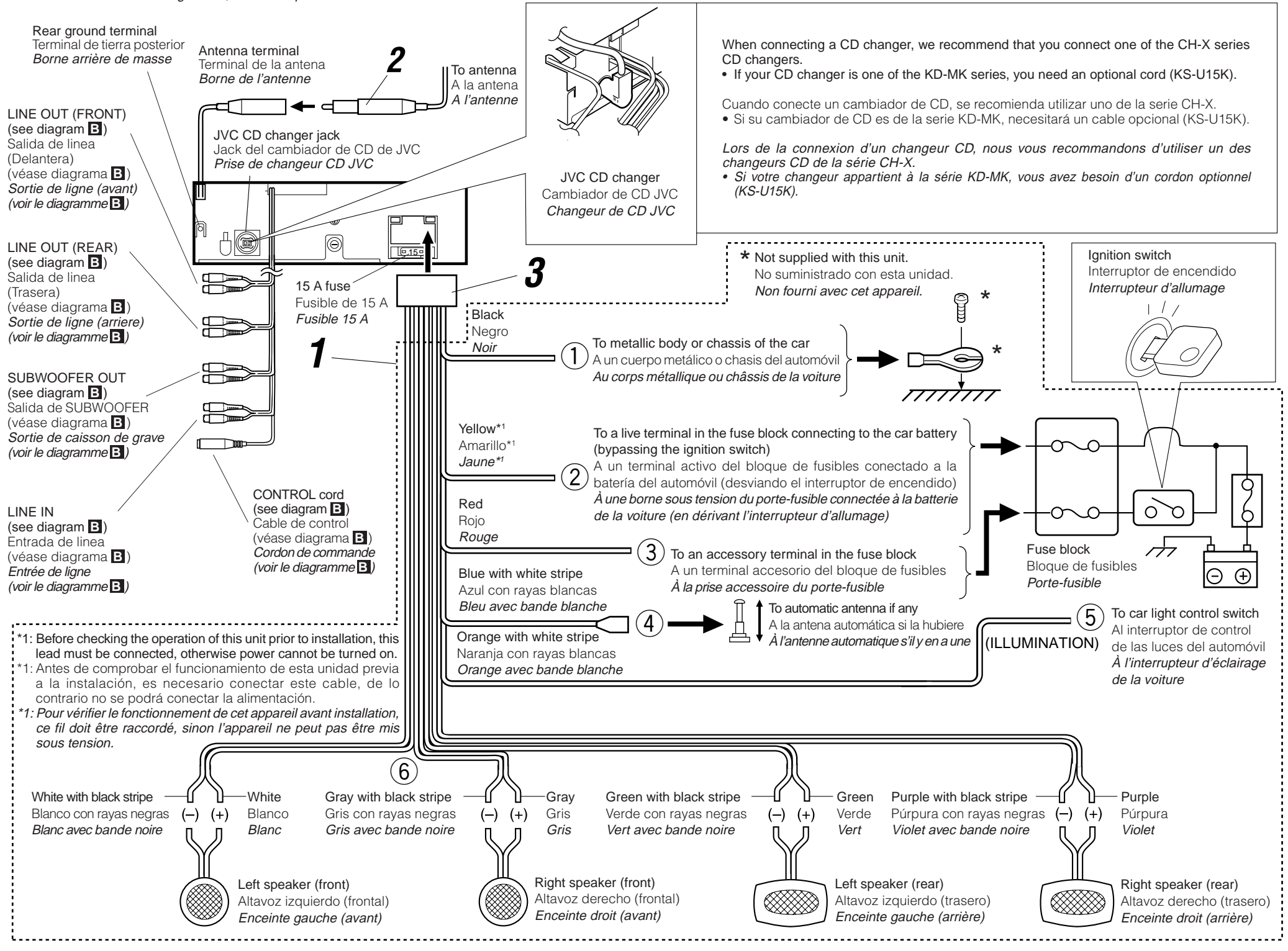

PRECAUTIONS on power supply and speaker connections:

- DO NOT connect the speaker leads of the power cord to the car battery; otherwise, the unit will be seriously damaged.
- Connect the black lead (ground), yellow lead (to car battery, constant 12 V), and red lead (to an accessory terminal) correctly.
- BEFORE connecting the speaker leads of the power cord to the speakers, check the speaker wiring in your car.
 - If the speaker wiring in your car is as illustrated in Fig. 1 and Fig. 2 below, DO NOT connect the unit using that original speaker wiring. If you do, the unit will be seriously damaged. Redo the speaker wiring so that you can connect the unit to the speakers as illustrated in Fig. 3.
 - If the speaker wiring in your car is as illustrated in Fig. 3, you can connect the unit using the original speaker wiring in your car.
 - If you are not sure of the speaker wiring of your car, consult your car dealer.

PRECAUCIONES sobre las conexiones de la fuente de alimentación y de los altavoces:

- NO conecte los conductores de altavoz del cable de alimentación a la batería de automóvil, pues podrían producirse graves daños en la unidad.
- Conecte correctamente el conductor negro (a tierra), el conductor amarillo (a la batería del automóvil, 12 V constantes), y el conductor rojo (a un terminal de accesorio).
- ANTES de conectar a los altavoces los conductores de altavoz del cable de alimentación, verifique el conexionado de altavoz de su automóvil.
 - Si el conexionado de altavoz de su automóvil es como se indica en las Fig. 1 y Fig. 2 de abajo, NO conecte la unidad utilizando ese conexionado de altavoz original. Si lo hace, se producirán daños graves en la unidad. Vuelva a efectuar el conexionado de altavoz de manera que pueda conectar la unidad a los altavoces de la manera indicada en la Fig.3.
 - Si el conexionado de altavoz de su automóvil es como se indica en la Fig. 3, podrá conectar la unidad utilizando el conexionado de altavoz original de su automóvil.
 - Si tiene dudas sobre el conexionado de altavoz de su automóvil, consulte con su concesionario.

PRECAUTIONS sur l'alimentation et la connexion des enceintes:

- NE CONNECTEZ PAS les fils d'enceintes du cordon d'alimentation à la batterie; sinon, l'appareil serait sérieusement endommagé.
- Connectez correctement le fil noir (a la masse), le fil jaune (a la batterie de la voiture, 12 V constant) et le fil rouge (à la prise accessoire).
- AVANT de connecter les fils d'enceintes du cordon d'alimentation aux enceintes, vérifiez le câblage des enceintes de votre voiture.
 - Si le câblage des enceintes de votre voiture est réalisé comme montré sur la Fig. 1 ou Fig. 2 ci-dessous, NE CONNECTEZ PAS l'appareil en utilisant ce câblage original d'enceintes. Si vous le faites, l'appareil sera sérieusement endommagé. Recommencez le câblage des enceintes de façon que vous puissiez connecter l'appareil aux enceintes comme montré sur la Fig. 3.
 - Si le câblage des enceintes de votre voiture est comme montré sur la Fig. 3, vous pouvez connecter l'appareil en utilisant ce câblage original d'enceintes pour votre voiture.
 - Si vous n'êtes pas sûrs du câblage d'enceintes de votre voiture, consultez le concessionnaire de votre voiture.

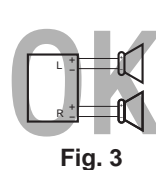
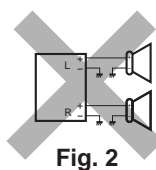
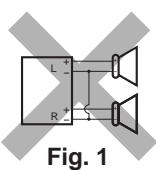

Connecting the leads / Conexión de los conductores / Raccordement des fils

Twist the core wires when connecting.
Retuerza los alambres de alma para conectarlos.
Torsader les âmes des fils en les raccordant.

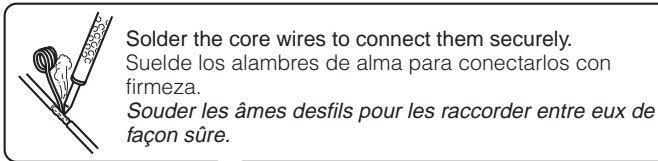

CAUTION / PRECAUCION / PRECAUTION:

- To prevent short-circuit, cover the terminals of the UNUSED leads with insulating tape.
- Para evitar cortocircuitos, cubra los cables NO UTILIZADOS con cinta aislante.
- Pour éviter les court-circuits, couvrir les bornes des fils qui ne sont PAS utilisés avec de la bande isolante.

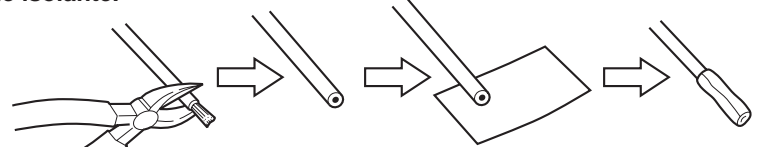

B Connections Adding Other Equipment / Conexiones para añadir otros equipos / Raccordement pour ajouter d'autres appareils

You can connect an amplifier and other equipment to upgrade your car stereo system.

- Connect the remote lead (blue with white stripe) to the remote lead of the other equipment so that it can be controlled through this unit.

For amplifier:

- Connect this unit's line-out terminals to the amplifier's line-in terminals.
- Disconnect the speakers from this unit, connect them to the amplifier. Leave the speaker leads of this unit unused.**
- You can switch off the built-in amplifier and send the audio signals only to the external amplifier(s) to get clear sounds and to prevent internal heat built-up inside the unit. See page 26 of the Instructions (separate volume).
- The line output level of this unit is kept high to maintain the hi-fi sounds reproduced from this unit.

When connecting an external amplifier to this unit, turn down the gain control on the external amplifier to obtain the best performance from this unit.

Usted podrá conectar un amplificador y otros equipos para mejorar el sistema estéreo de su automóvil.

- Conecte el conductor remoto (azul con rayas blancas) al conductor remoto del otro equipo para poderlo controlar a través de esta unidad.

Para el amplificador:

- Conecte los terminales de salida de línea de esta unidad a los terminales de entrada de línea del amplificador.
- Desconecte los altavoces de esta unidad y conéctelos al amplificador. Deje los conductores de los altavoces de esta unidad sin usar.**
- Podrá desconectar el amplificador incorporado y enviar las señales de audio solamente al(los) amplificador(es) externo(s) para obtener sonidos nítidos y evitar que se caliente el interior de la unidad. Véase la página 26 de las instrucciones (volumen separado).
- El nivel de salida de línea de esta unidad permanece alto para que corresponda con los sonidos de alta fidelidad reproducidos por esta unidad.

Quando conecte un amplificador externo a esta unidad, disminuya el control de ganancia del amplificador externo para obtener un óptimo rendimiento de esta unidad.

Vous pouvez connecter un amplificateur ou autre appareil pour améliorer votre système autoradio.

- Connectez le fil de commande à distance (bleu avec bande blanche) au fil de commande à distance de l'autre appareil de façon qu'il puisse être commandé via cet appareil.

Pour l'amplificateur:

- Raccordez les fiches de sortie ligne de cet appareil aux fiches d'entrée ligne de l'amplificateur.
- Déconnectez les enceintes de cet appareil et connectez-les à l'amplificateur. Laissez les fils d'enceintes de cet appareil inutilisés.**
- Vous pouvez désactiver l'amplificateur intégré et envoyer les signaux audio uniquement à un ou plusieurs amplificateurs extérieurs afin d'obtenir un son clair et pour éviter un échauffement interne de l'appareil. Référez-vous à la page 26 du mode d'emploi (volume séparé).
- Le niveau de sortie de ligne de cet appareil est maintenu à un niveau élevé pour maintenir une qualité Hi-Fi pour les sons reproduits par cet appareil.

Lors de la connexion d'un amplificateur extérieur à cet appareil, diminuez le réglage du gain sur l'amplificateur extérieur pour obtenir les meilleures performances de cet appareil.

Amplifier / Amplificador / Amplificateur

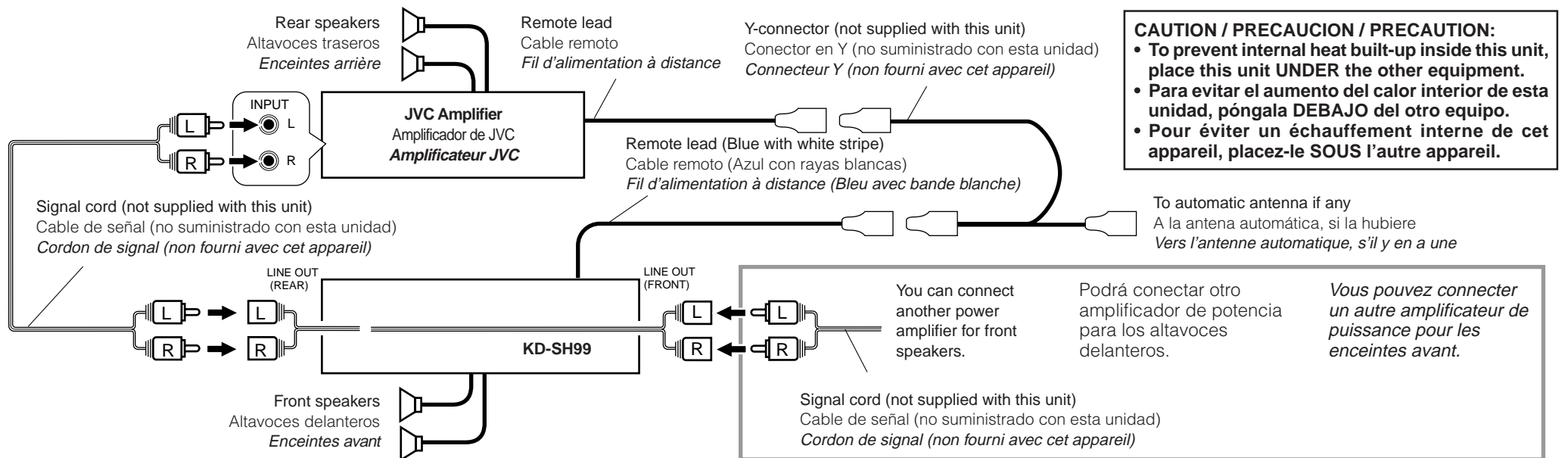

Subwoofer (SUB WOOFER OUT) / Subwoofer (Salida de SUB WOOFER) / Caisson de grave (Sortie de caisson de grave)

You can connect a subwoofer through an amplifier to reinforce the bass.

- For their connections, refer to the instructions supplied with your subwoofer.

Usted podrá conectar un subwoofer a través de un amplificador para reforzar los graves.

- Con respecto a sus conexiones, refiérase a las instrucciones suministradas con sus subwoofer.

Vous pouvez connecter un caisson de grave par un amplificateur pour renforcer les graves.

- Pour la connexion, référez-vous aux instructions fournies avec le caisson de grave.

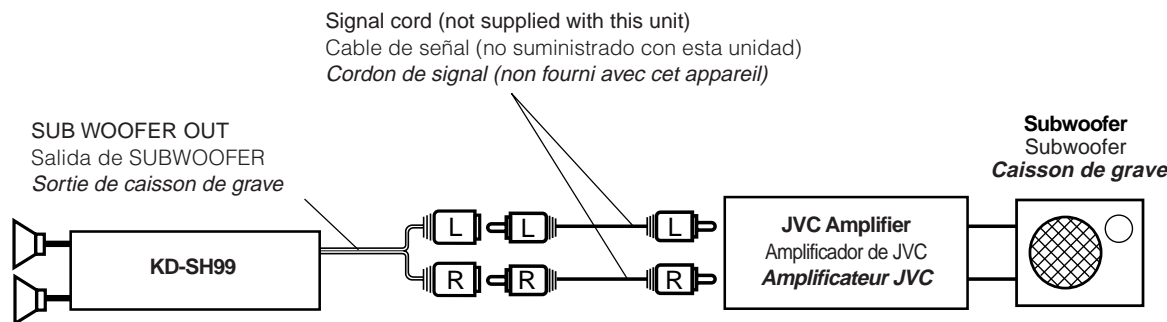

DVD, VCR or TV / DVD, VCR o TV / DVD, Magnétoscope ou Téléviseur

